

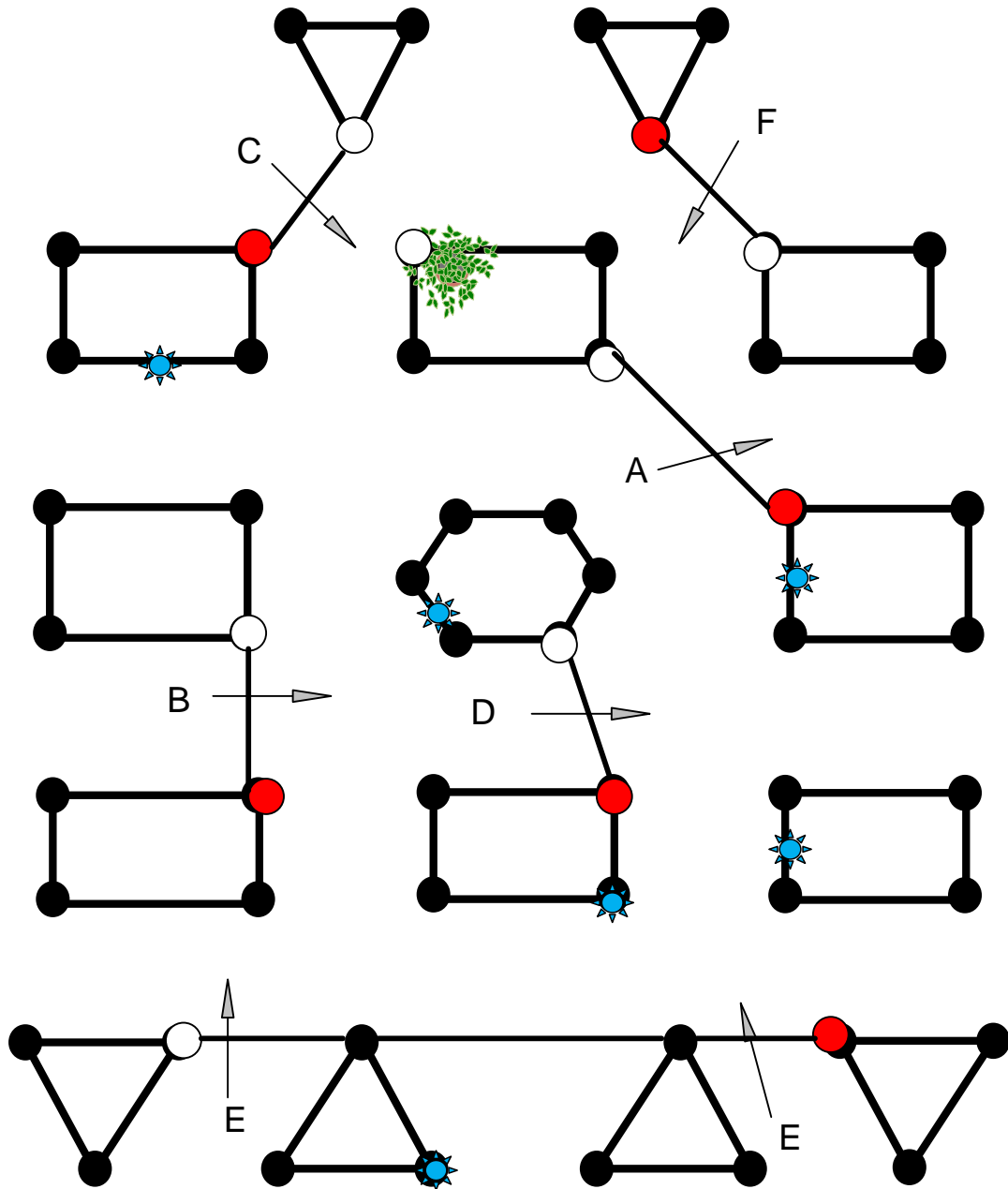

# Obstacle 1. Sägewerk Stösser Bühl



Children CAICh: A-D  
 6 Knock Downs

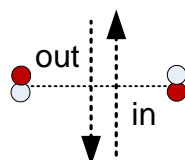

Course Designer  
 Henning Lemcke  
 Urs Bernhard

# Obstacle 2. Sicon Gescher

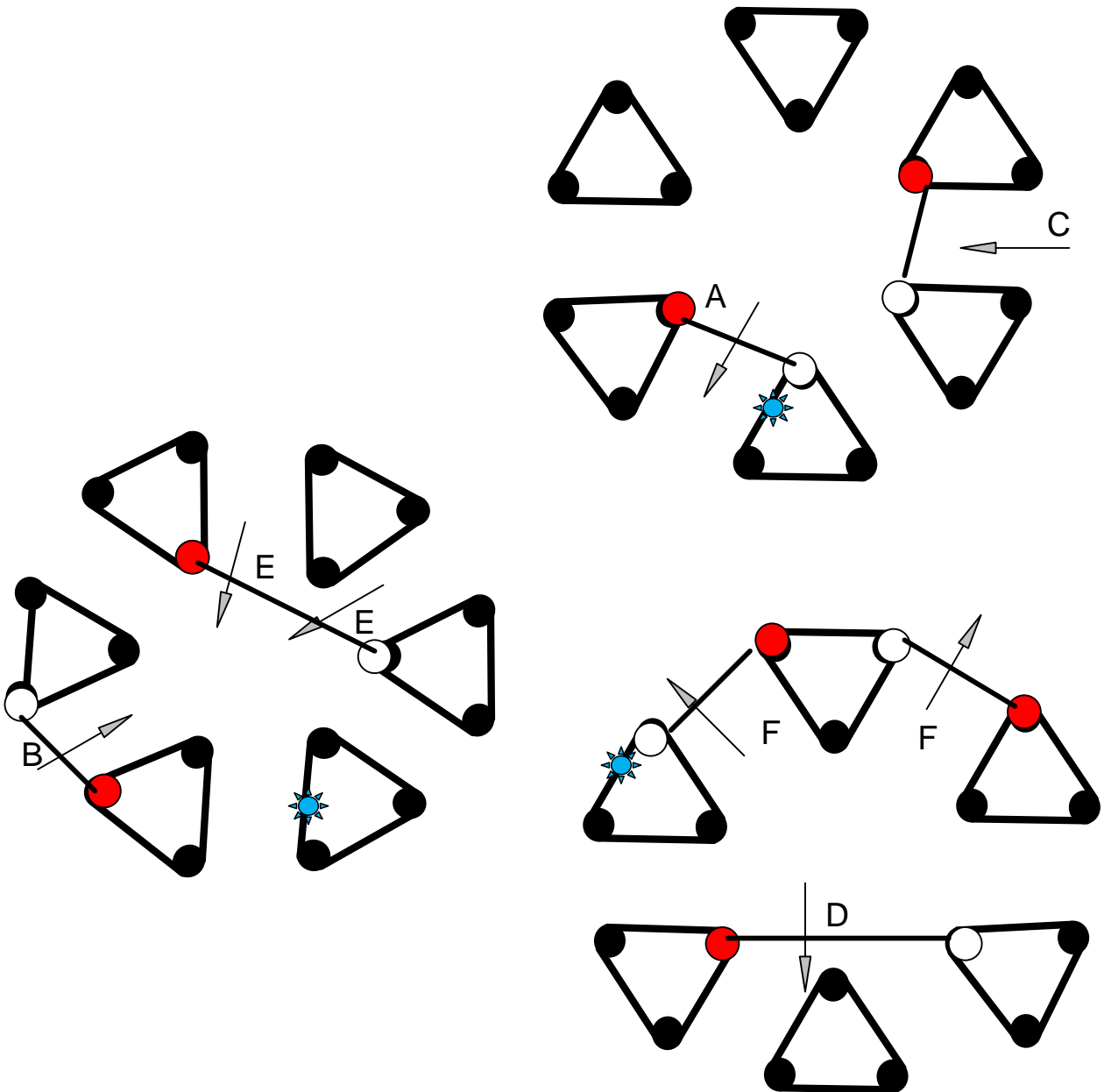

# Obstacle 3. Best Wood Kontor

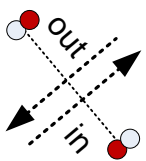
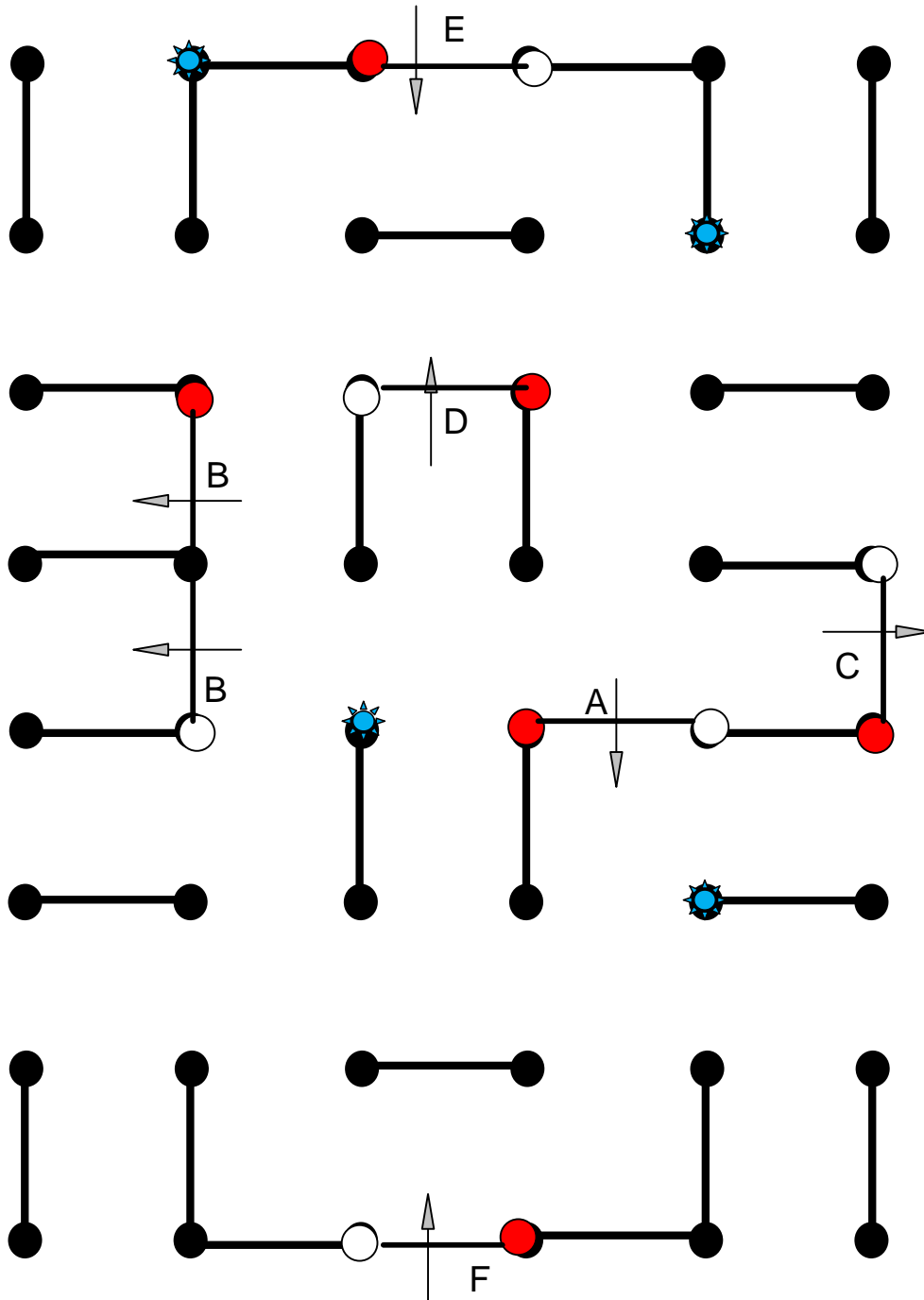

Children CAICh: A-D

 4 Knock Downs



Course Designer  
Henning Lemcke  
Urs Bernhard

# Obstacle 4. Umweltpartner Vogel AG

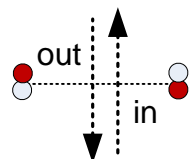
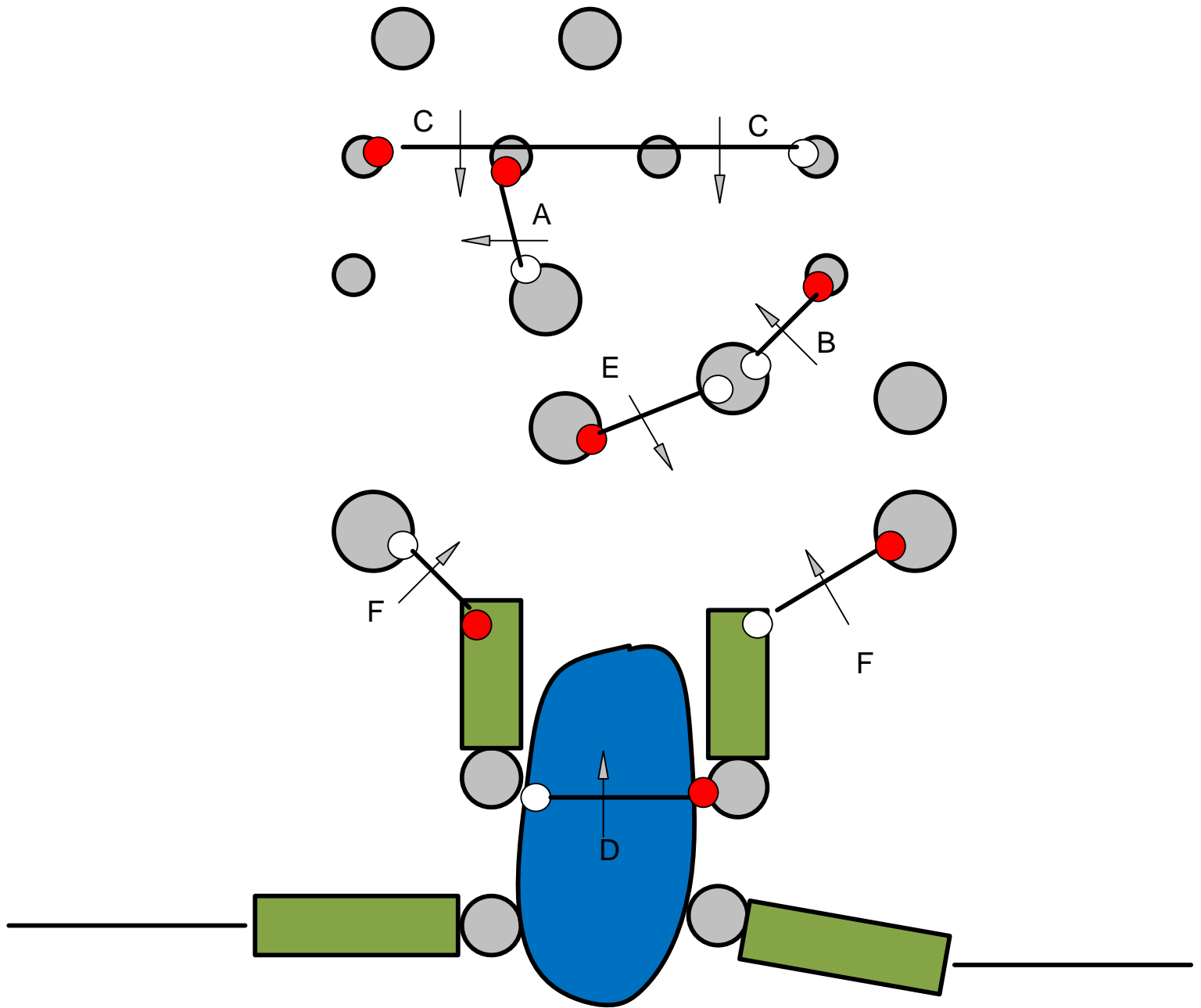

Children CAICh: A-D



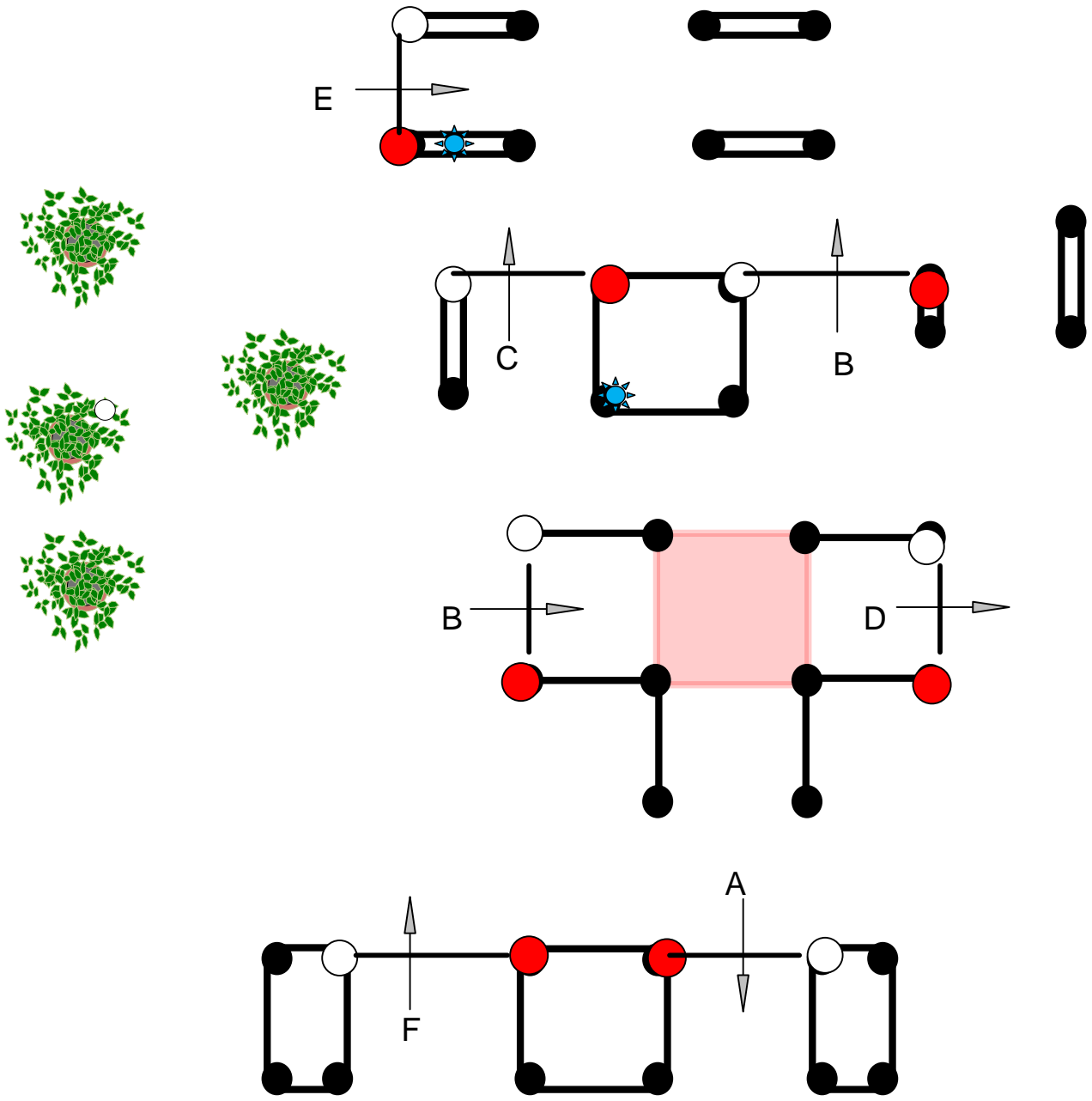

Course Designer  
Henning Lemcke  
Urs Bernhard

# Obstacle5. Hopp Schwiz

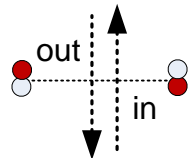

Course Designer  
Henning Lemcke  
Urs Bernhard



Children CAICh: A-D  
 2 Knock Downs



# Obstacle 7. Druckerei Stolzenberger

