

Obstacle 1: GMT Bühl

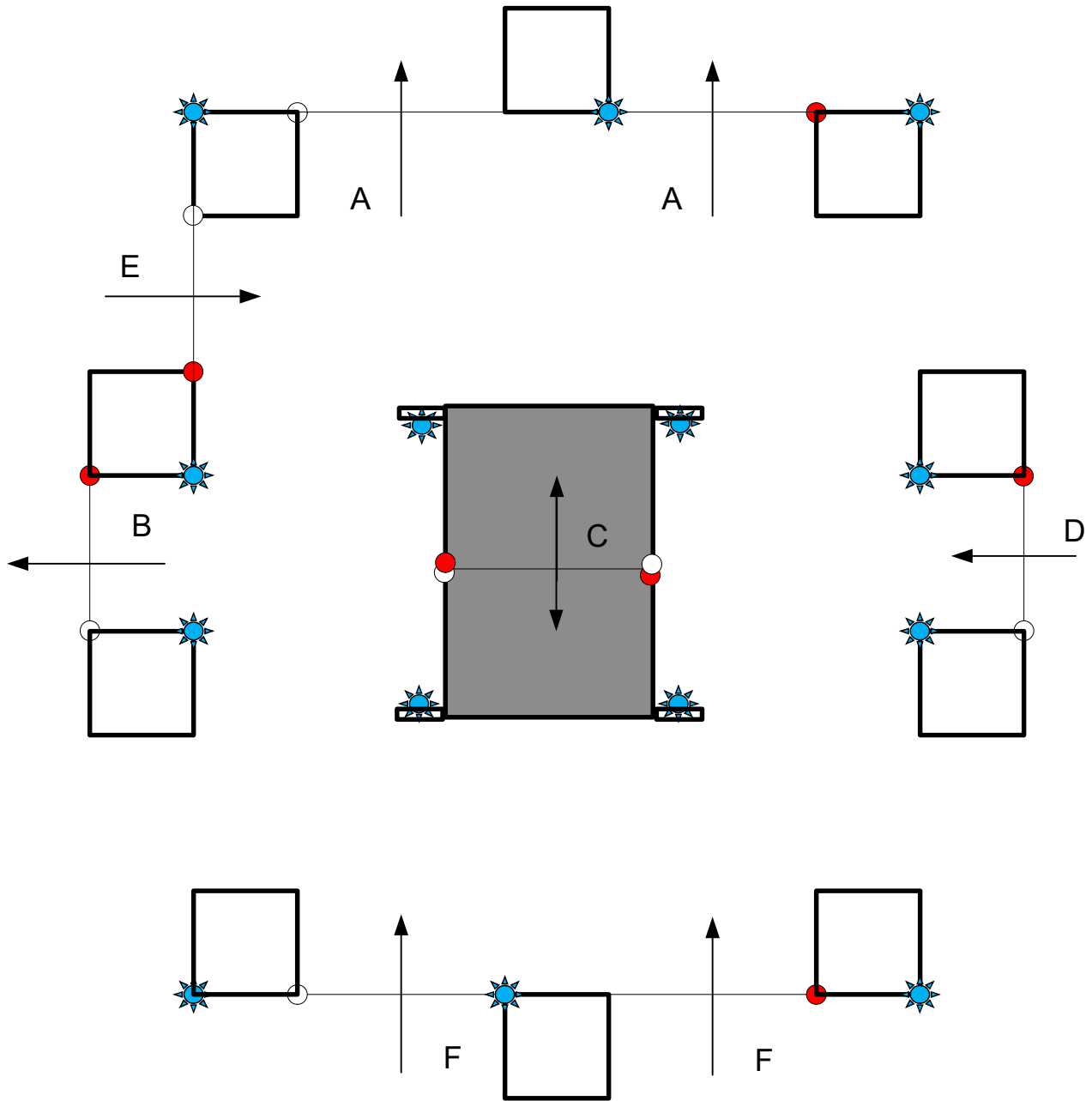

Obstacle 2: Sägewerk Stösser Bühl

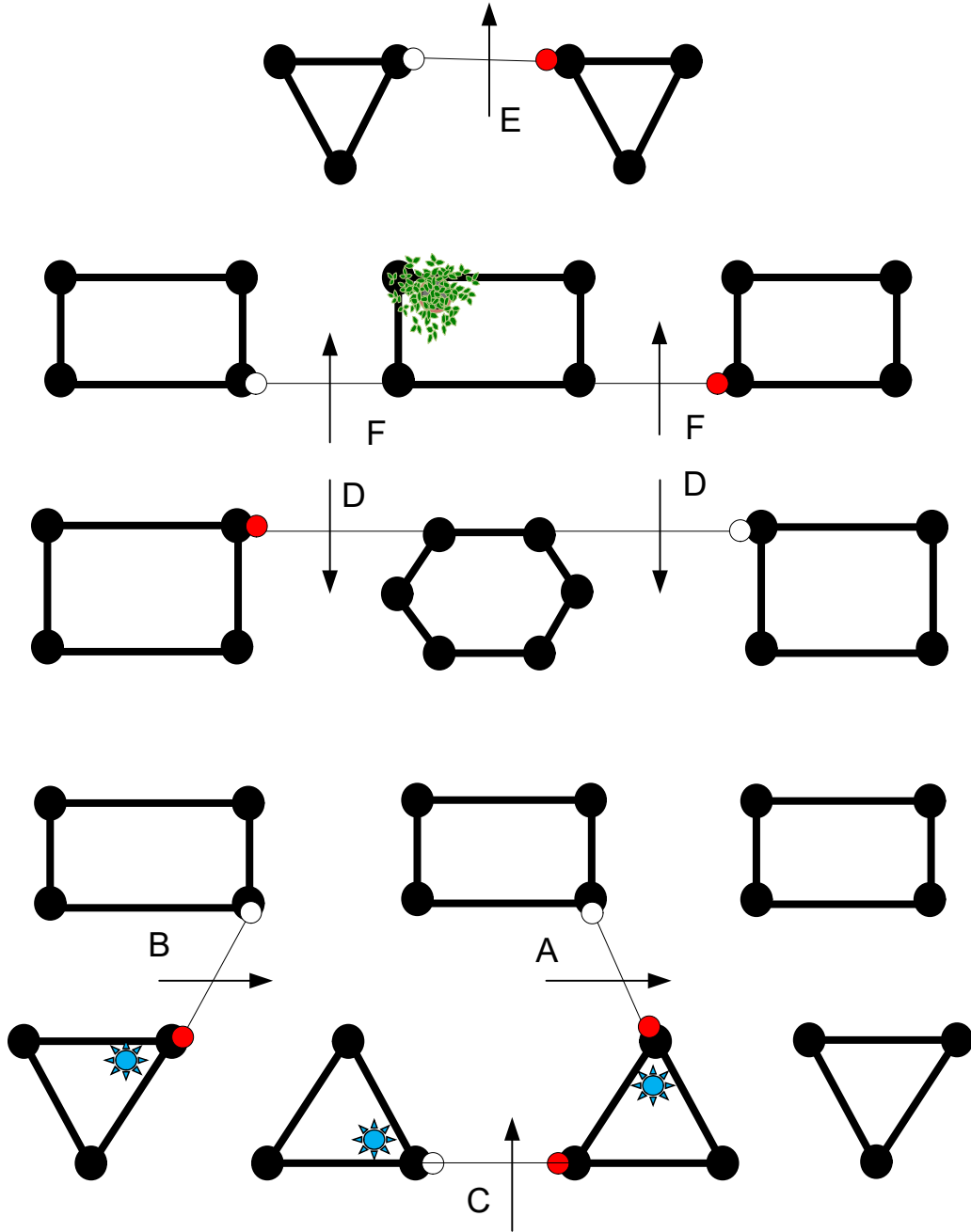

Children CAICh: A-D

 3 Knock Downs

Obstacle 3: Sicon Gescher

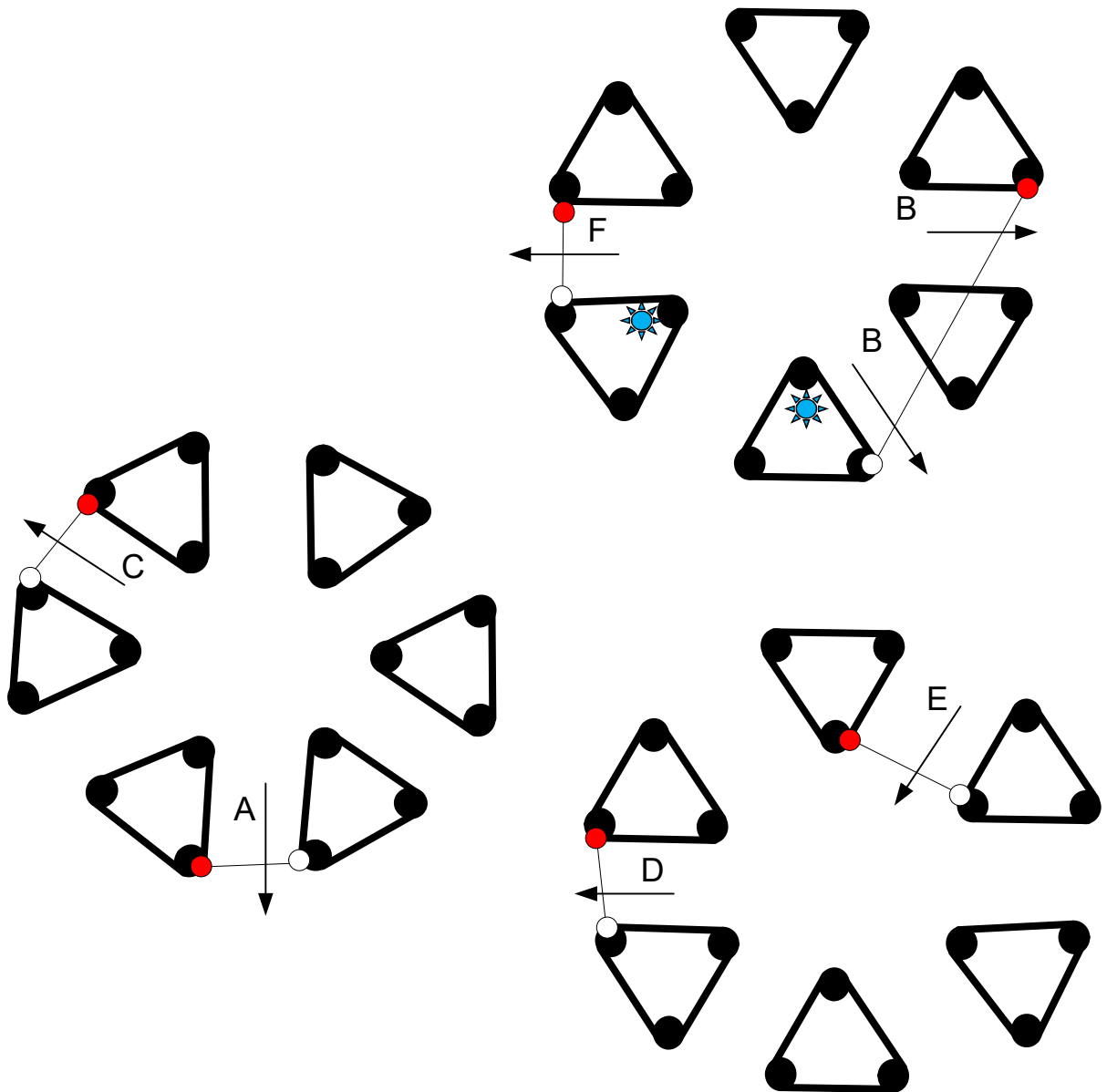

Obstacle 4: Boehringer Vet Medica / Tierarztpraxis Oberlin

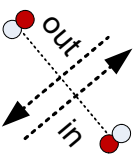
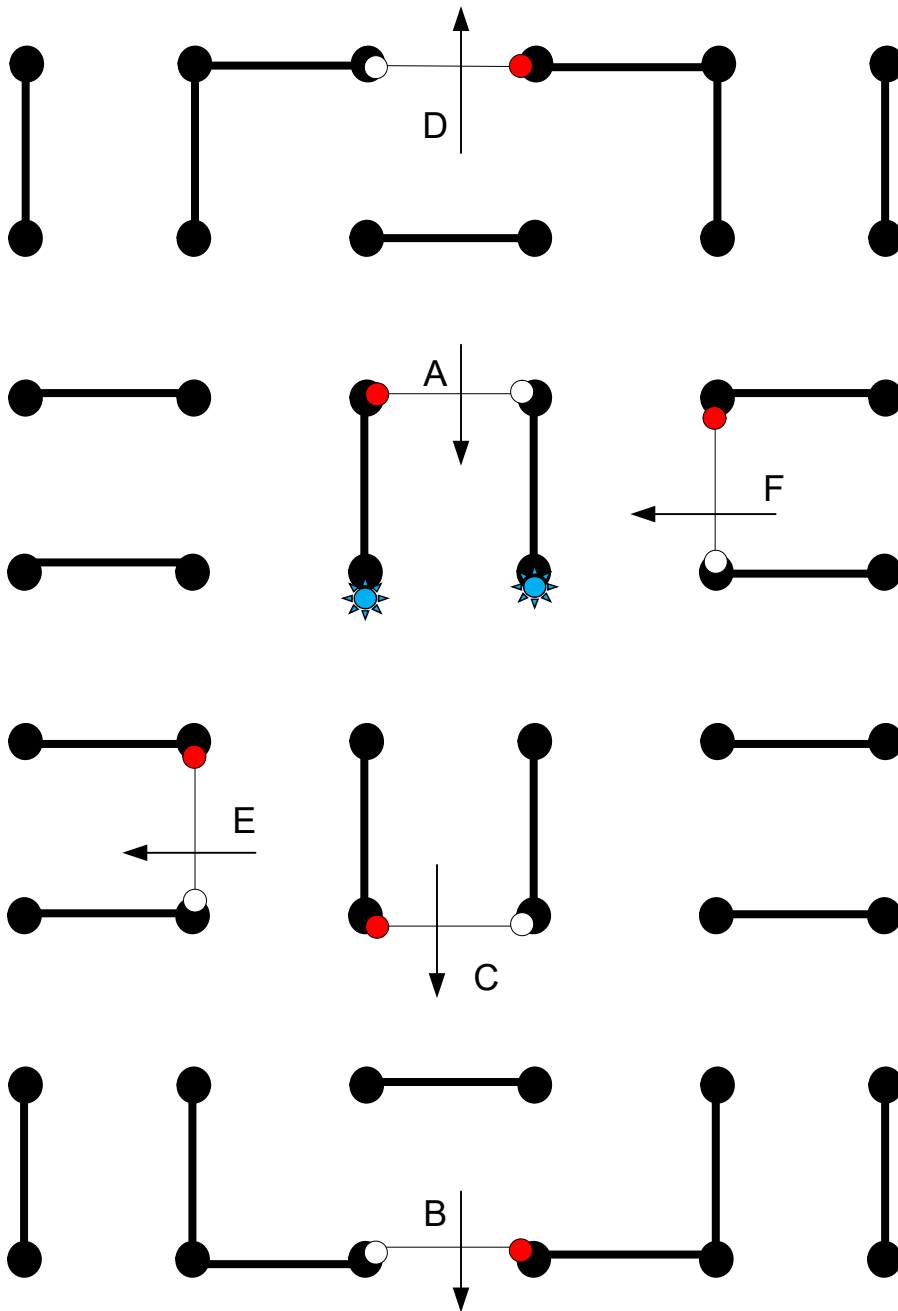

Children CAICh: A-D

 2 Knock Downs

Obstacle 5: Umweltpartner Vogel AG

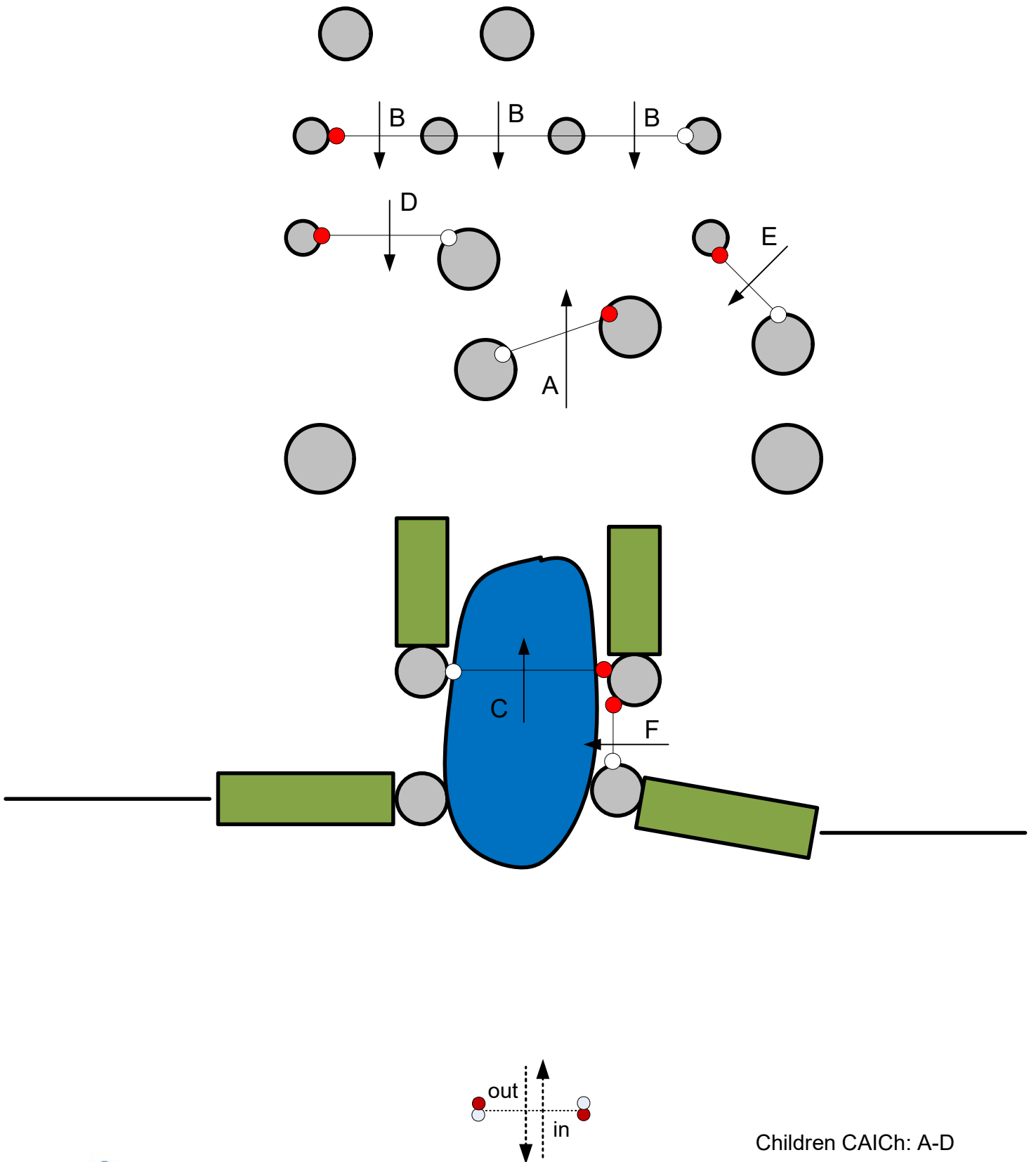

Children CAICh: A-D

Obstacle 6: Sparkasse Bühl

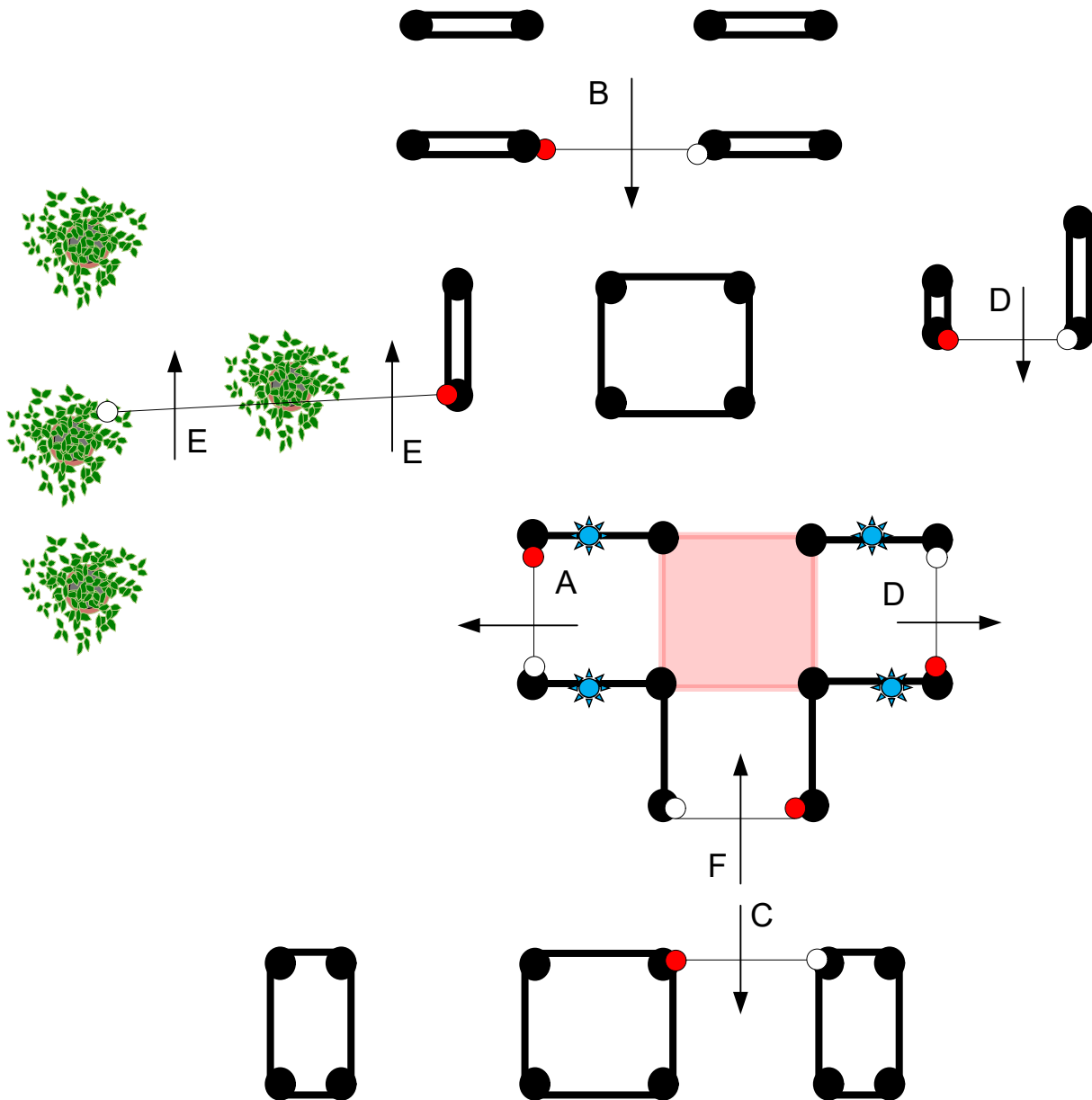

Obstacle 7: Druckerei Stolzenberger

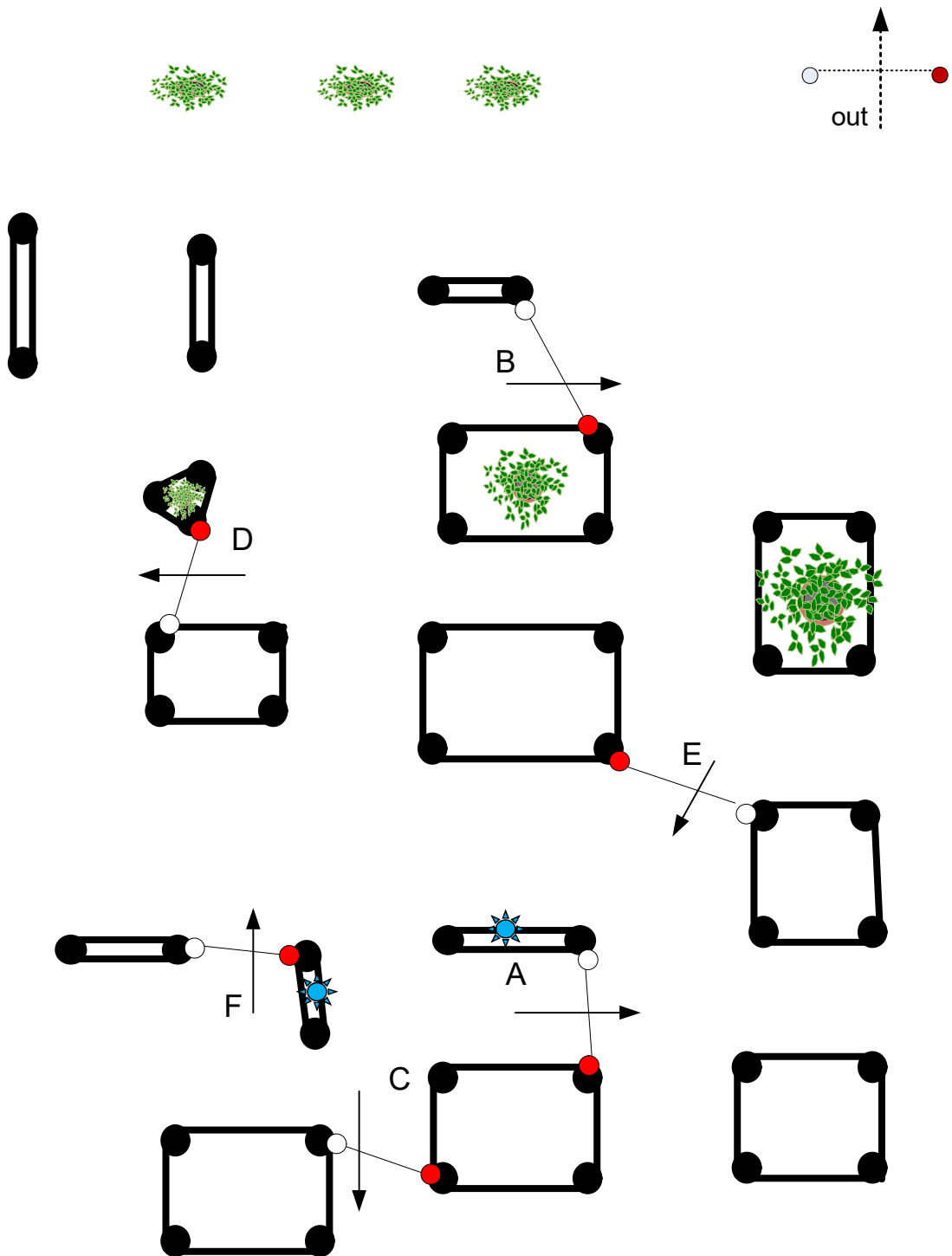

Children CAICh: A-D

 2 Knock Down