

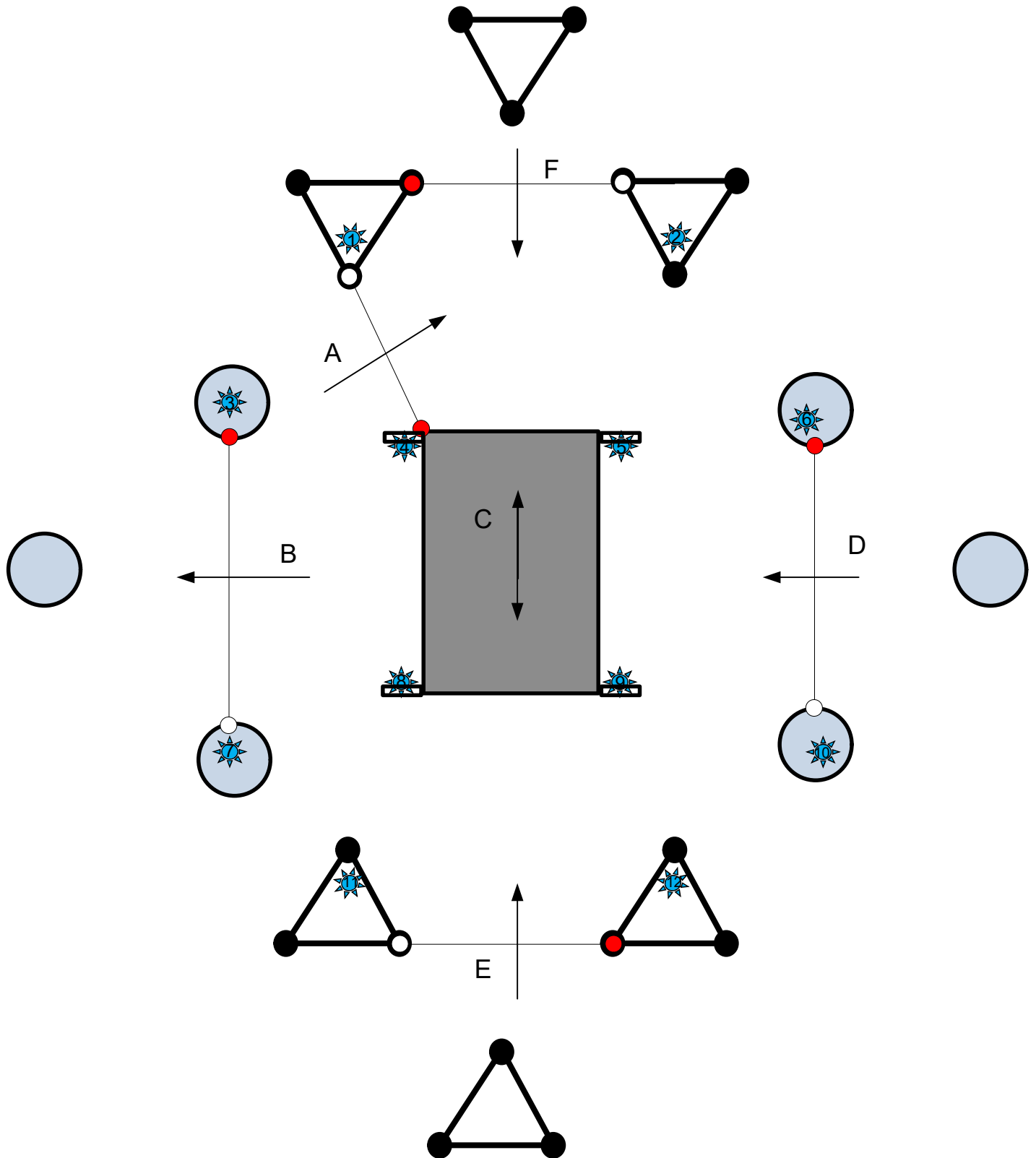

Obstacle 1: GMT Bühl



 12 Knock Downs



Michael Mayer | 
Course Designer michael-mayer.ch

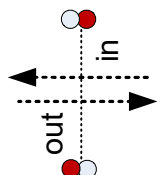

Obstacle 2: Sägewerk Stösser Bühl

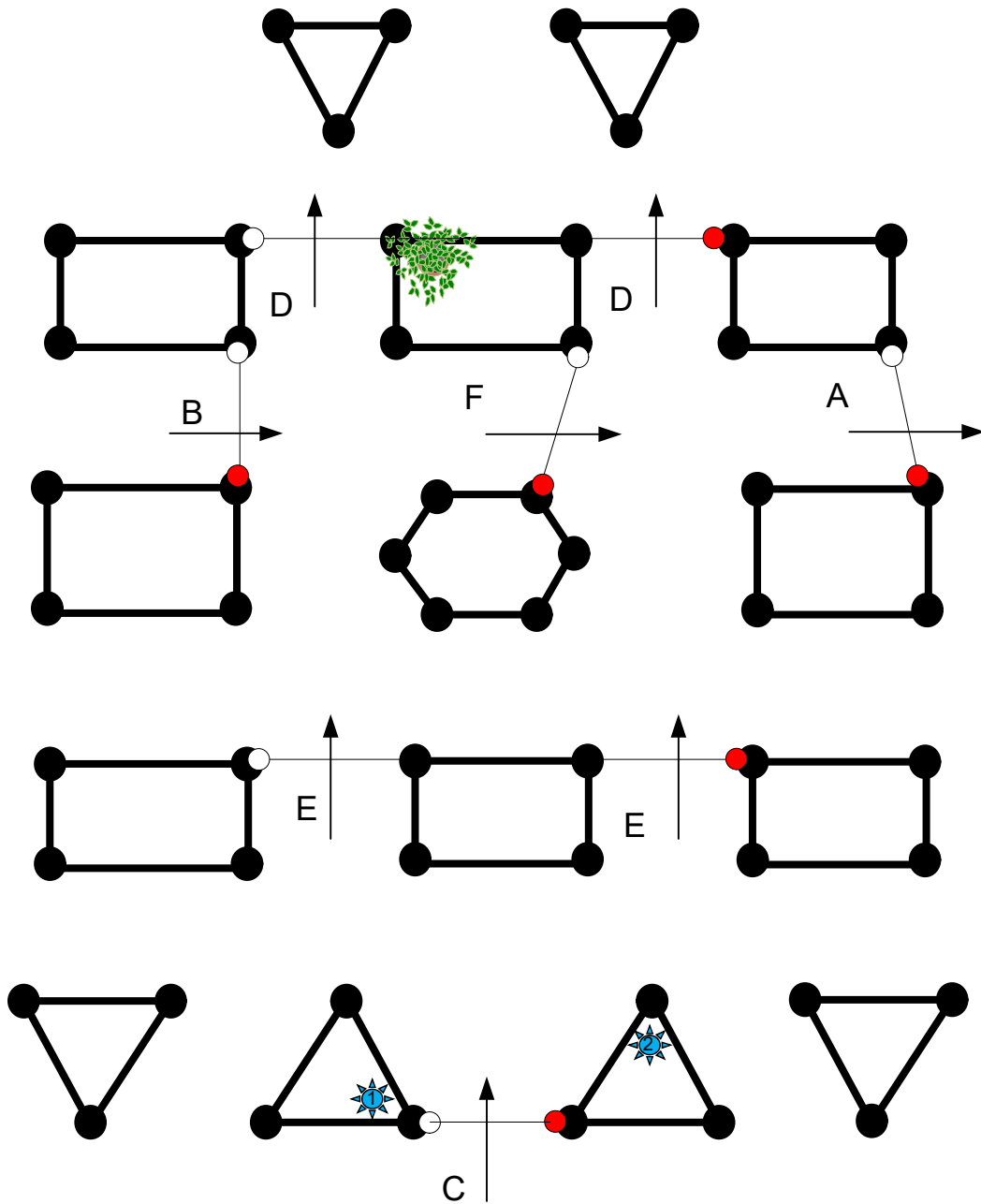

Children CAICh: A-D
 Juniors CAIJ: A-F

 2 Knock Downs

Obstacle 3: Sicon Gescher

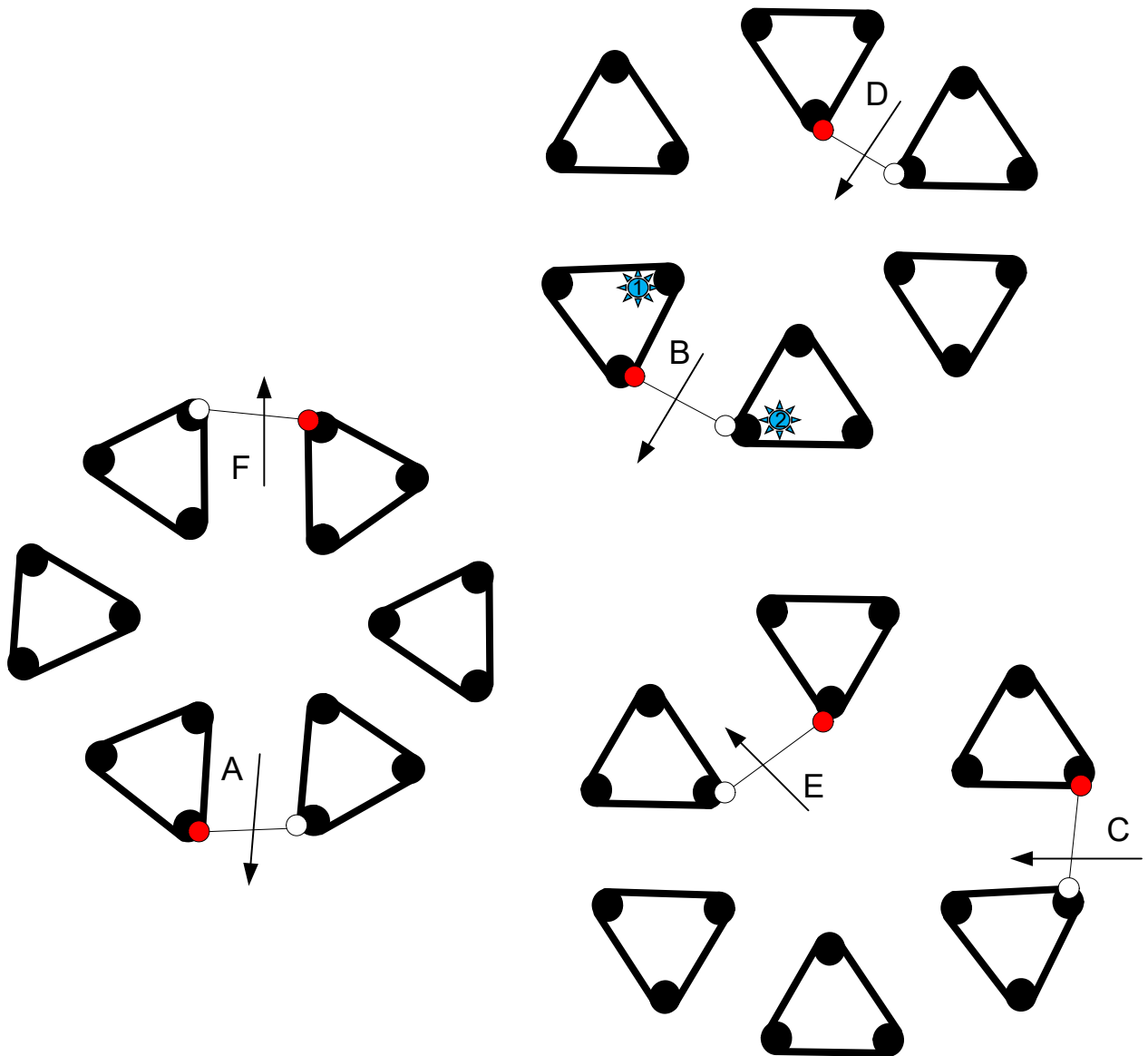

Children CAICh: A-D
Juniors CAIJ: A-F

 2 Knock Downs

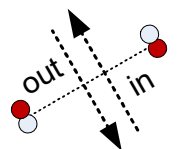

Michael Mayer | 
Course Designer michael-mayer.ch

Obstacle 4: Boehringer Vet Medica / Tierarztpraxis Oberlin

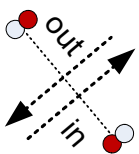
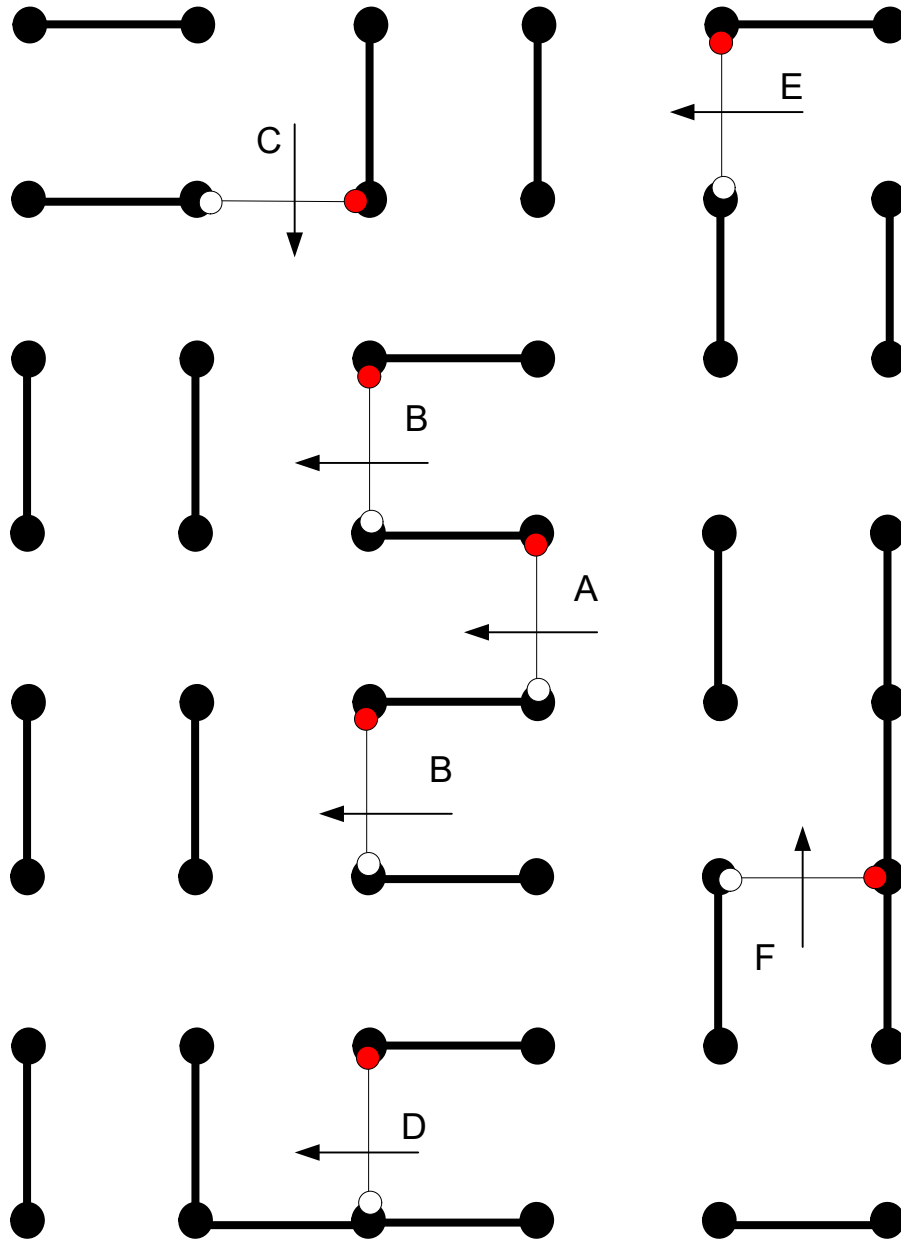

Children CAICh: A-D
Juniors CAIJ: A-F

Obstacle 5: Umweltpartner Vogel AG

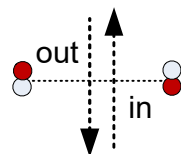
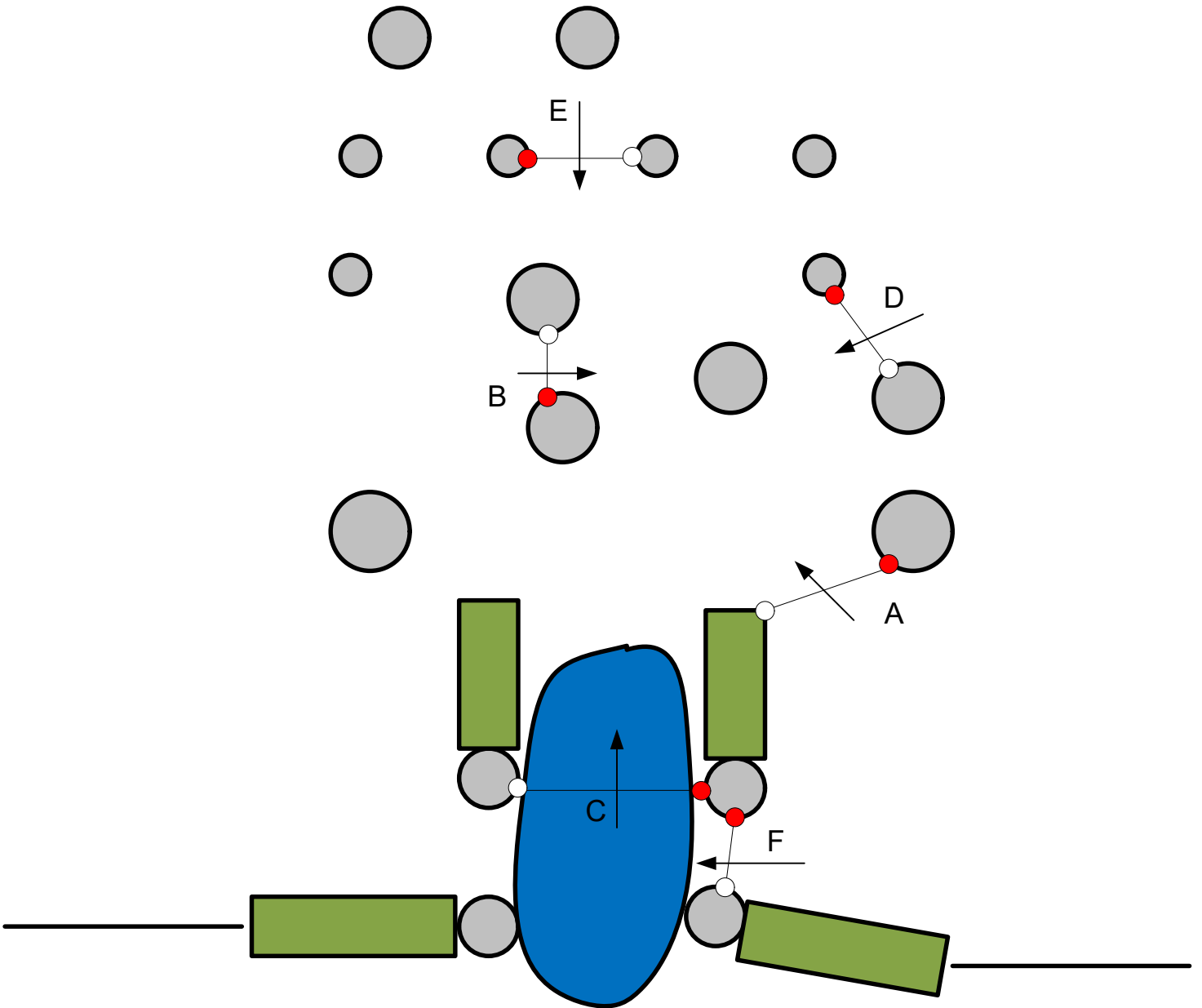

Children CAICh: A-D
Juniors CAIJ: A-F

Obstacle 6: Sparkasse Bühl

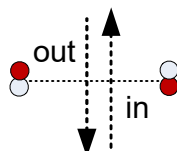
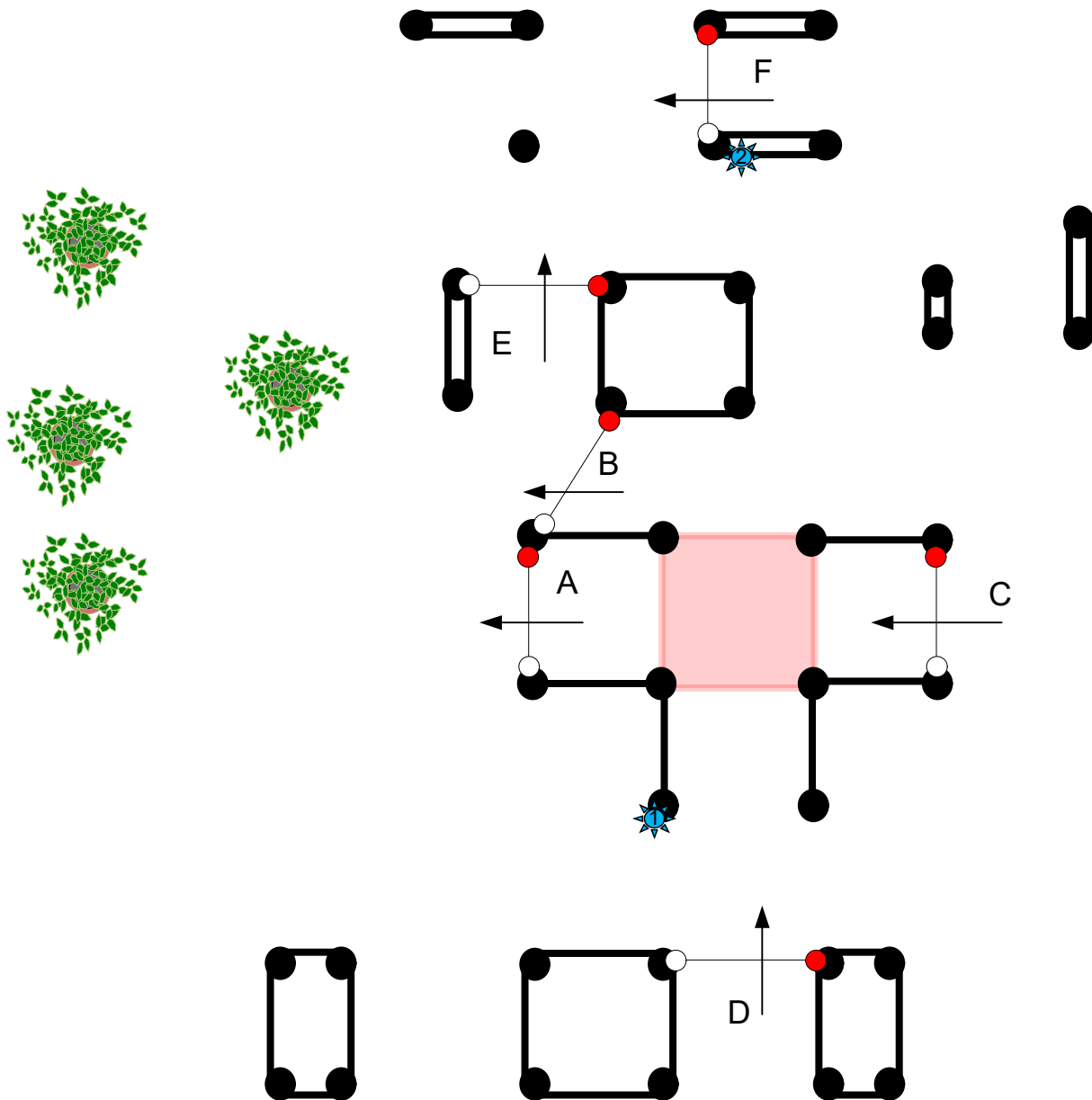

Juniors CAIJ: A-F

 2 Knock Downs

Obstacle 7: Druckerei Stolzenberger

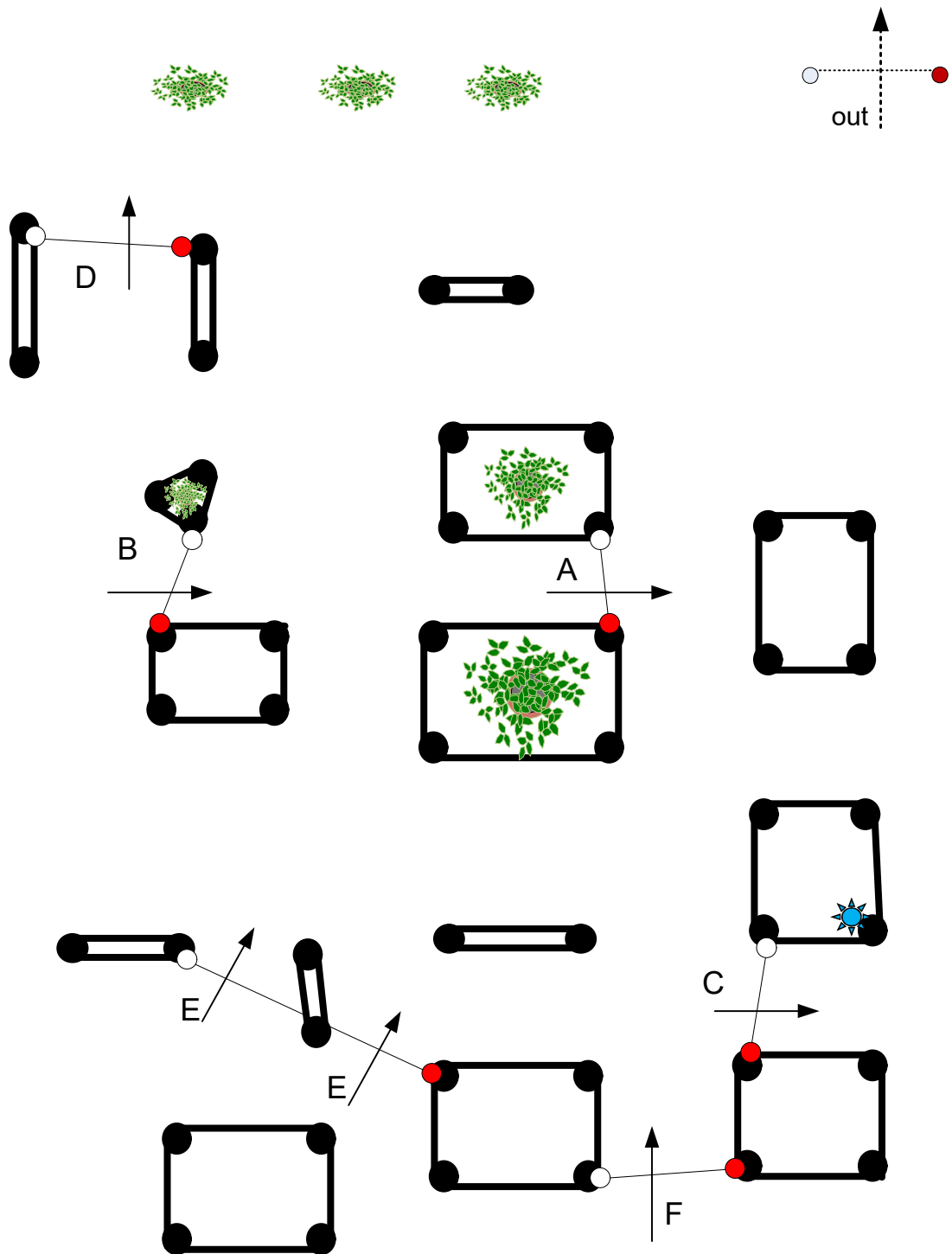

Children CAICh: A-D
 Juniors CAIJ: A-F

 1 Knock Down

Michael Mayer | 
 Course Designer michael-mayer.ch

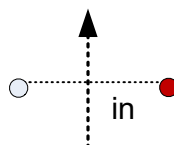

Section A

Distance: 6400m

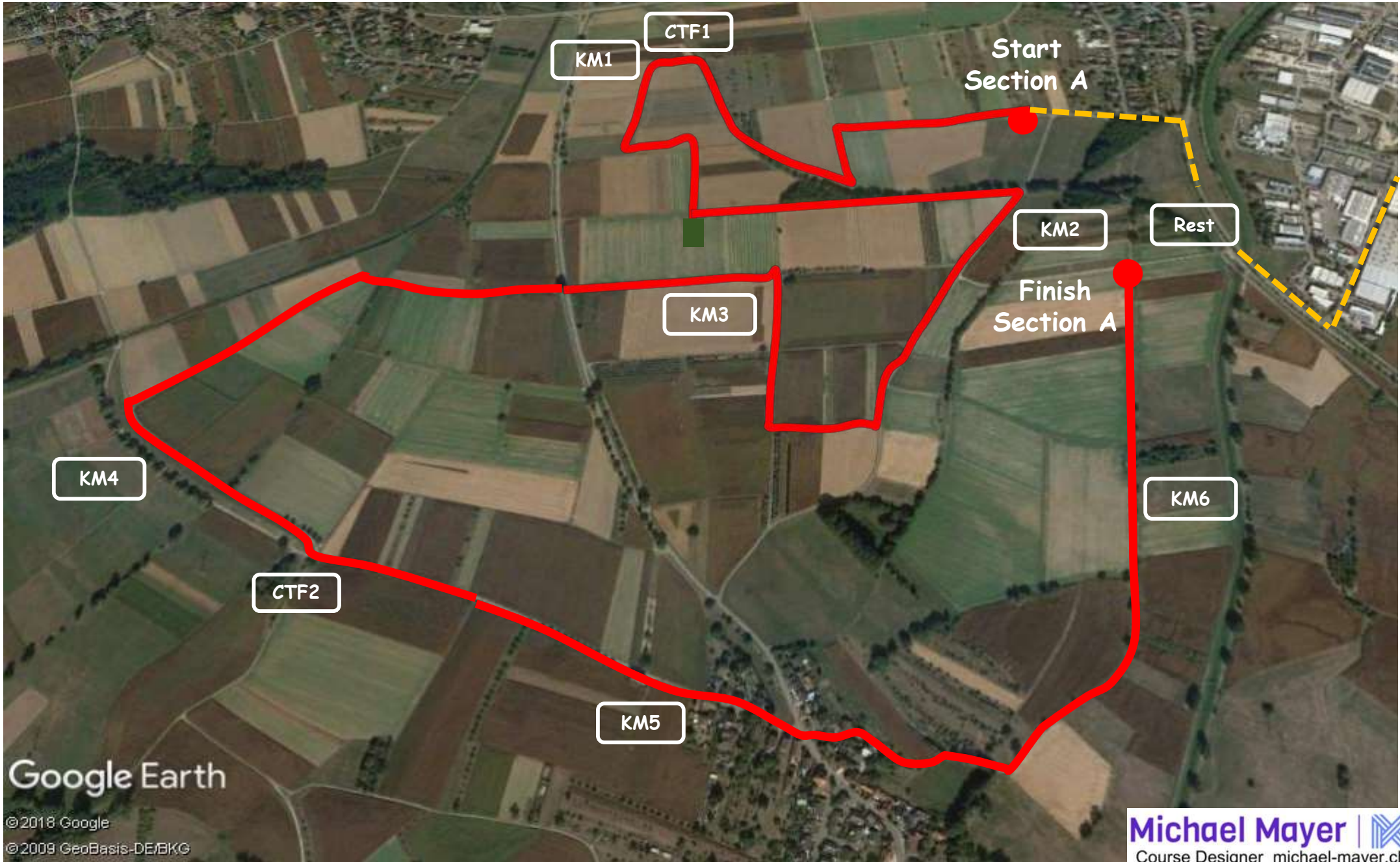

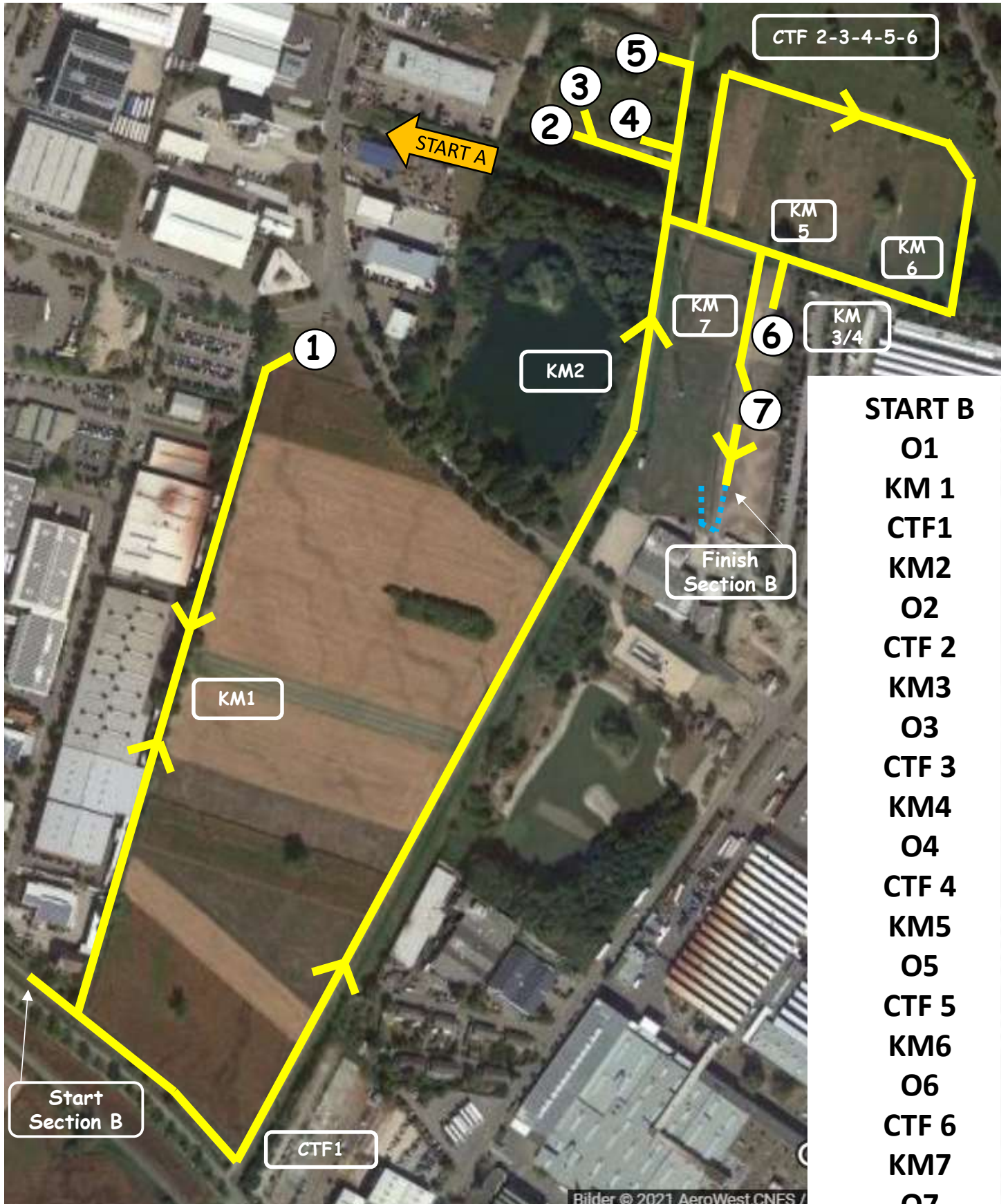

START B

- O1
- KM 1
- CTF1
- KM2
- O2
- CTF 2
- KM3
- O3
- CTF 3
- KM4
- O4
- CTF 4
- KM5
- O5
- CTF 5
- KM6
- O6
- CTF 6
- KM7
- O7
- FINISH B**

Section B CAICh

Distance: 5230m

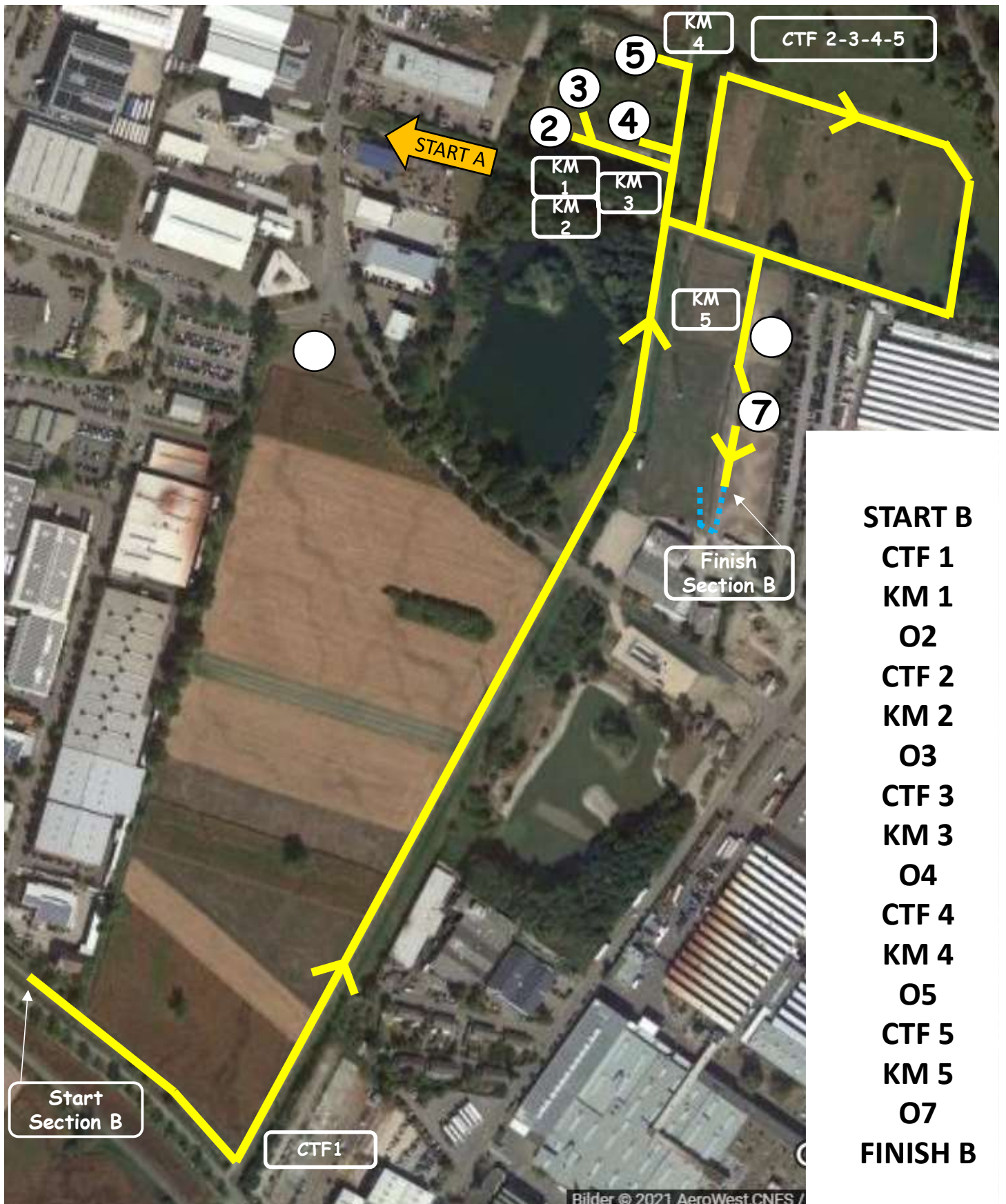

- START B
- CTF 1
- KM 1
- 02
- CTF 2
- KM 2
- 03
- CTF 3
- KM 3
- 04
- CTF 4
- KM 4
- 05
- CTF 5
- KM 5
- 07
- FINISH B

Bilder © 2021 AeroWest, CNES /

Section B CAIJ

Distance: 6210m

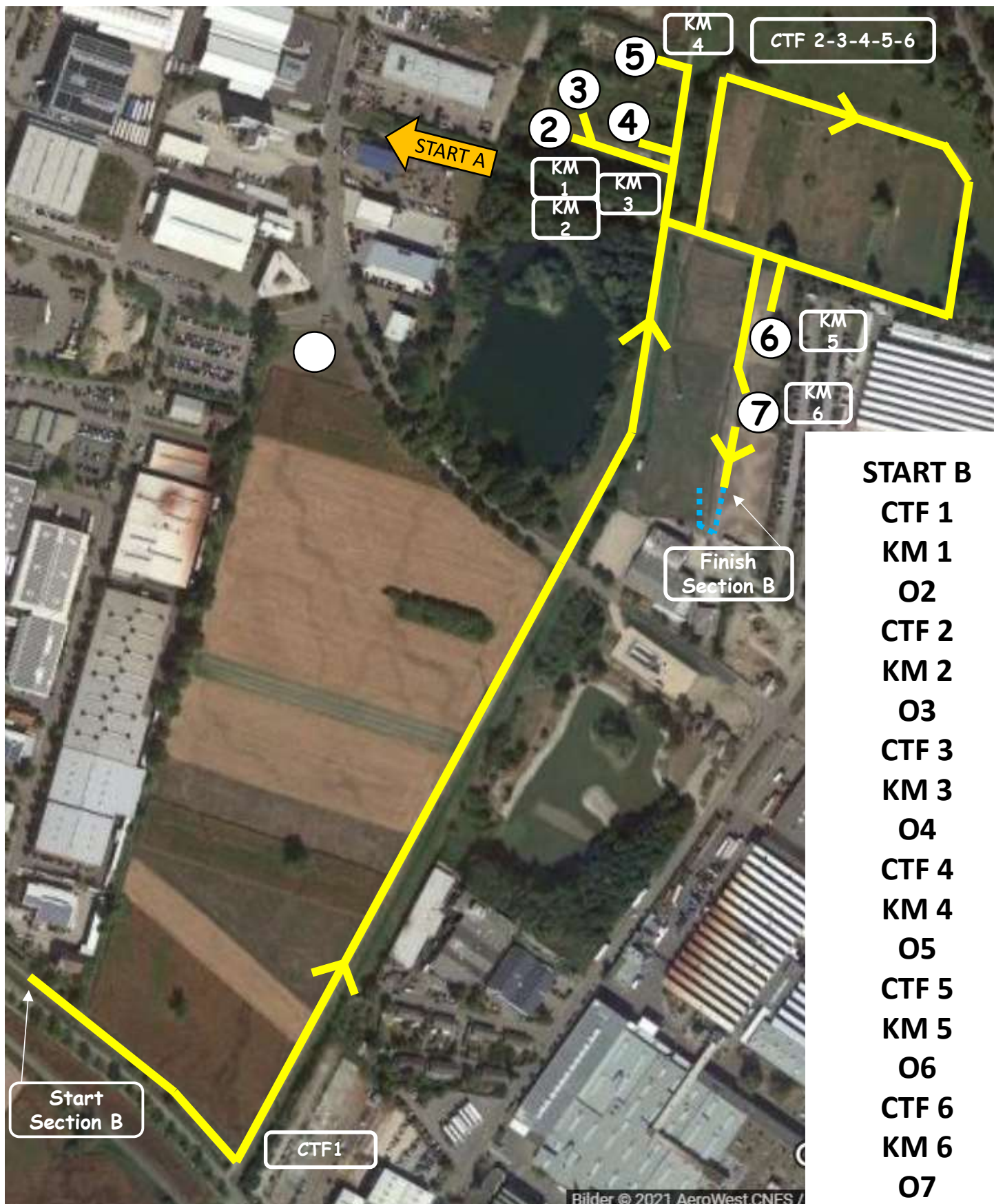

START B

CTF 1

KM 1

O2

CTF 2

KM 2

O3

CTF 3

KM 3

O4

CTF 4

KM 4

O5

CTF 5

KM 5

O6

CTF 6

KM 6

O7

FINISH B



CAI 2* Bühl GER
Marathon
05.06.2021

Michael Mayer | 
Course Designer michael-mayer.ch

Section Times

Competition: CAI 2* H1-H2-P1-P2-P4

HORSES

Section	Distance	Pace	Speed	TA	MT		CTF
A	6400 m	free	13 km/h	29 min 32 sec	27 min 32 sec		1 - 2
Vet Check	10 min						
B	7330 m	free → after H7 walk or trot	14 km/h	31 min 25 sec	28 min 25 sec		1 - 6

PONYS

Section	Distance	Pace	Speed	TA	MT		CTF
A	6400 m	free	12 km/h	32 min 00 sec	30 min 00 sec		1 - 2
Vet Check	10 min						
B	7330 m	free → after H7 walk or trot	13 km/h	33 min 50 sec	30 min 50 sec		1 - 6

TA = Time Allowed / MT = Minimum Time / CTF = Compulsory Turning Flags



CAI 2* Bühl GER
Marathon
05.06.2021

Michael Mayer | 
Course Designer michael-mayer.ch

Section Times

Competition: CAI Children / Junior

CHILDREN

Section	Distance	Pace	Speed	TA	MT		CTF
A	6400 m	free	12 km/h	32 min 00 sec	32 min 00 sec		1 - 2
Vet Check	10 min						
B	5230 m	free → after H7 walk or trot	13 km/h	24 min 08 sec	21 min 08 sec		1 - 5

JUNIOR

Section	Distance	Pace	Speed	TA	MT		CTF
A	6400 m	free	12 km/h	32 min 00 sec	32 min 00 sec		1 - 2
Vet Check	10 min						
B	6210 m	free → after H7 walk or trot	13 km/h	28 min 40 sec	25 min 40 sec		1 - 6

TA = Time Allowed / MT = Minimum Time / CTF = Compulsory Turning Flags