

H 1

Stolzenberger Turm

STOLZENBERGER

DIGITAL . PRINT . MEDIEN

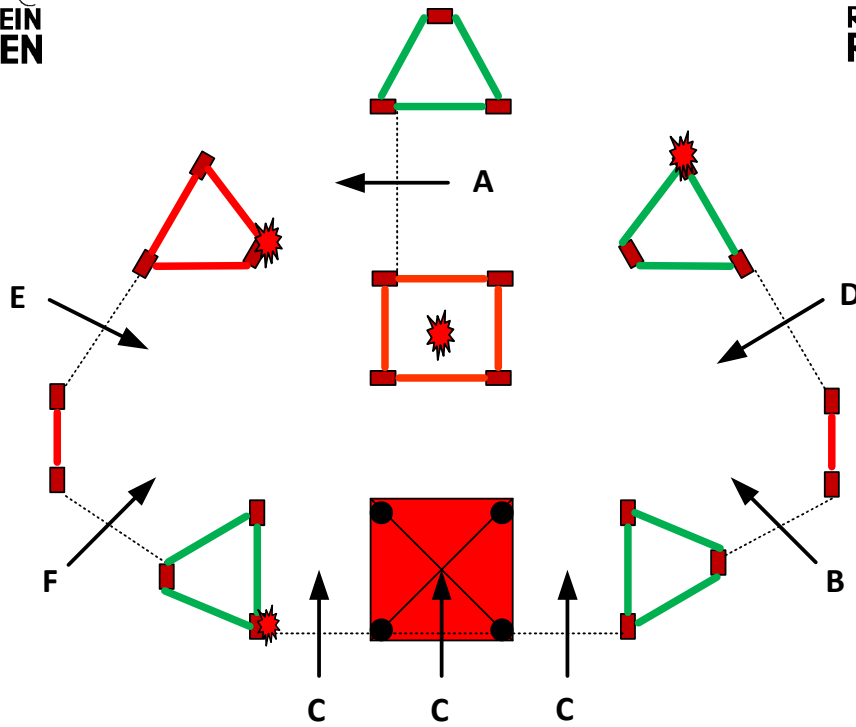

STOLZENBERGER

DIGITAL . PRINT . MEDIEN

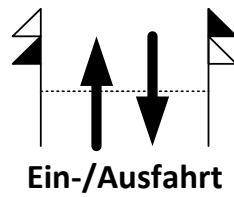

STOLZENBERGER

DIGITAL . PRINT . MEDIEN

Klasse S: A - F

Klasse M: A - E



= abwerfbare Teile = 4



Parcoursgestaltung
Rainer Doth

Reilingen 2019

BaWü. - MS 4.- sp. Pony + Pferde + Bad. MS 1.- und 2.-sp. Pony + Pferde

H 2

TOPFIT Irrgarten

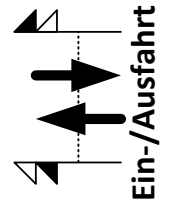
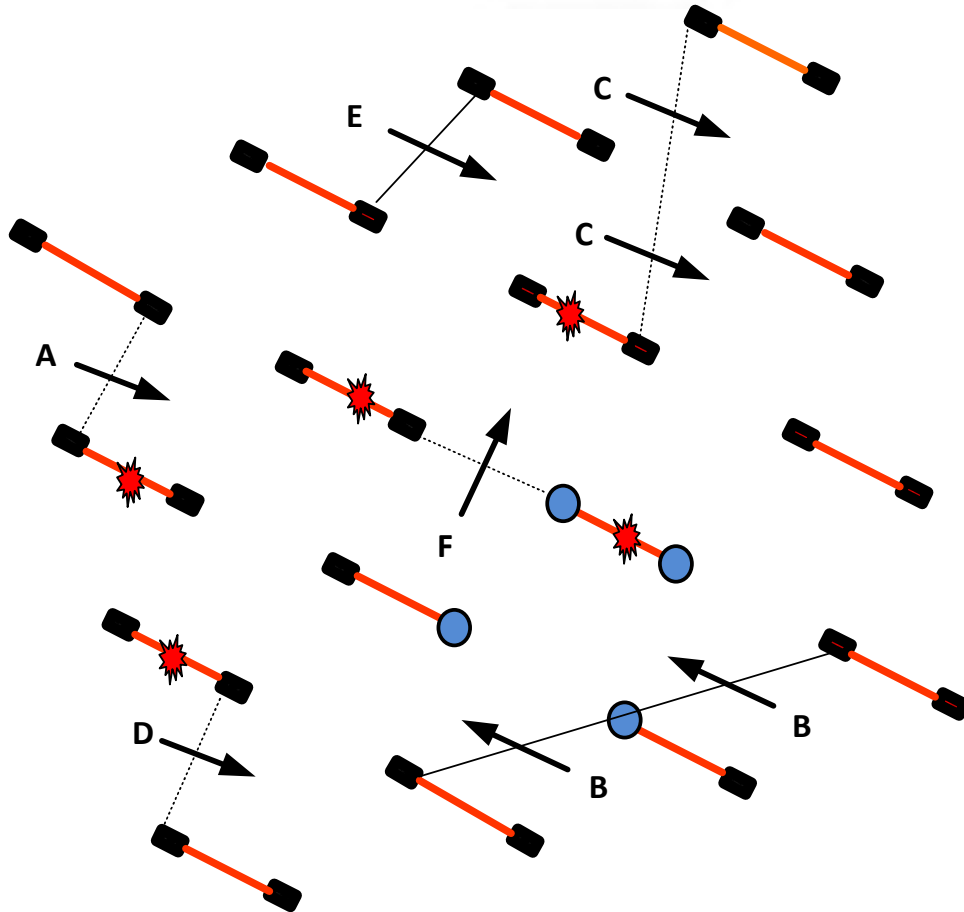

= abwerfbare Teile = 5

Klasse S: A - F
Klasse M: A - E



Reilingen 2019

BaWü. - MS 4.- sp. Pony + Pferde + Bad. MS 1.- und 2.-sp. Pony + Pferde

H 3

Schaumaplast

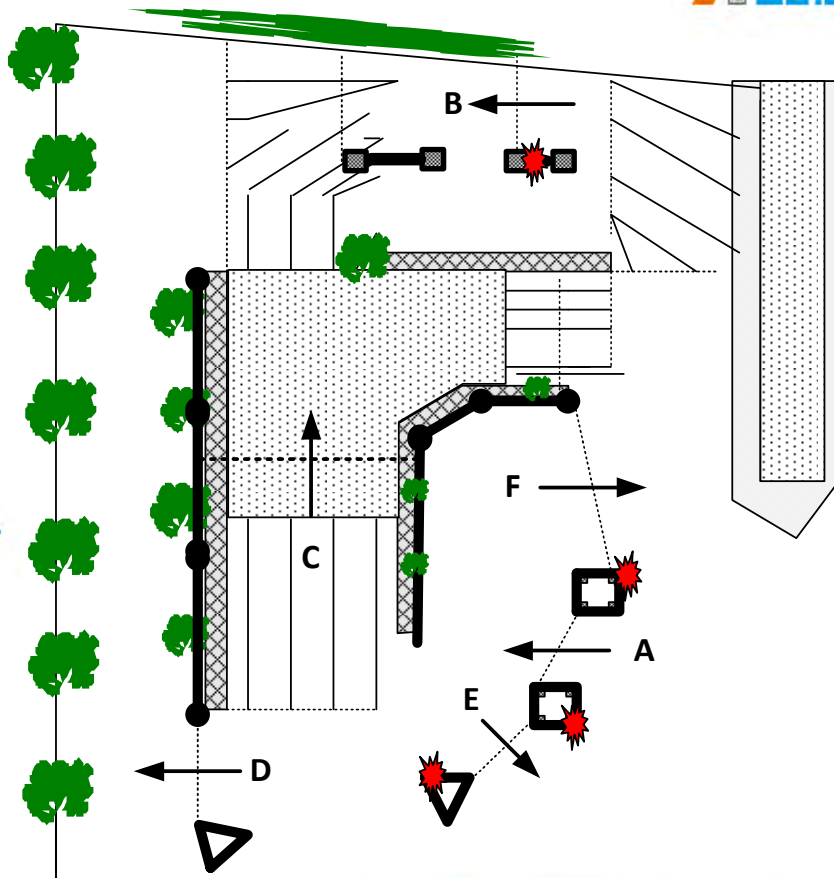

Parcoursgestaltung
Rainer Doth

= abwerfbare Teile = 4

Klasse S: A - F
Klasse M: A - E

Reilingen 2019

BaWü. - MS 4.- sp. Pony + Pferde + Bad. MS 1.- und 2.-sp. Pony + Pferde

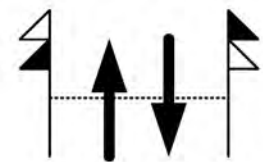
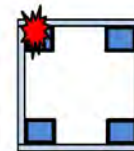
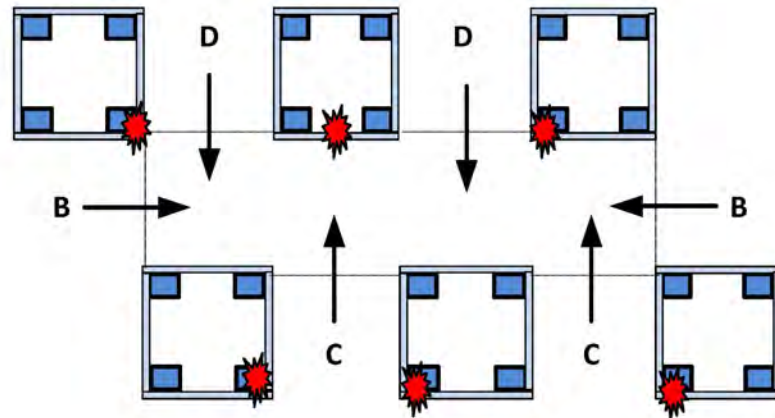
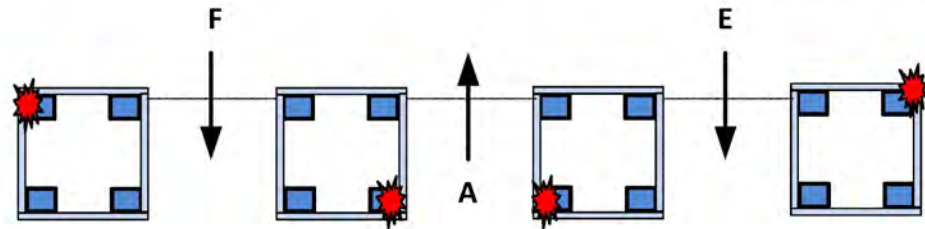

Ein-/Ausfahrt

= abwerfbare Teile = 11

Klasse S: A - F
Klasse M: A - E



Reilingen 2019

BaWü. - MS 4.- sp. Pony + Pferde + Bad. MS 1.- und 2.-sp. Pony + Pferde

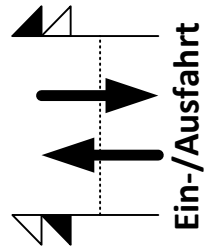
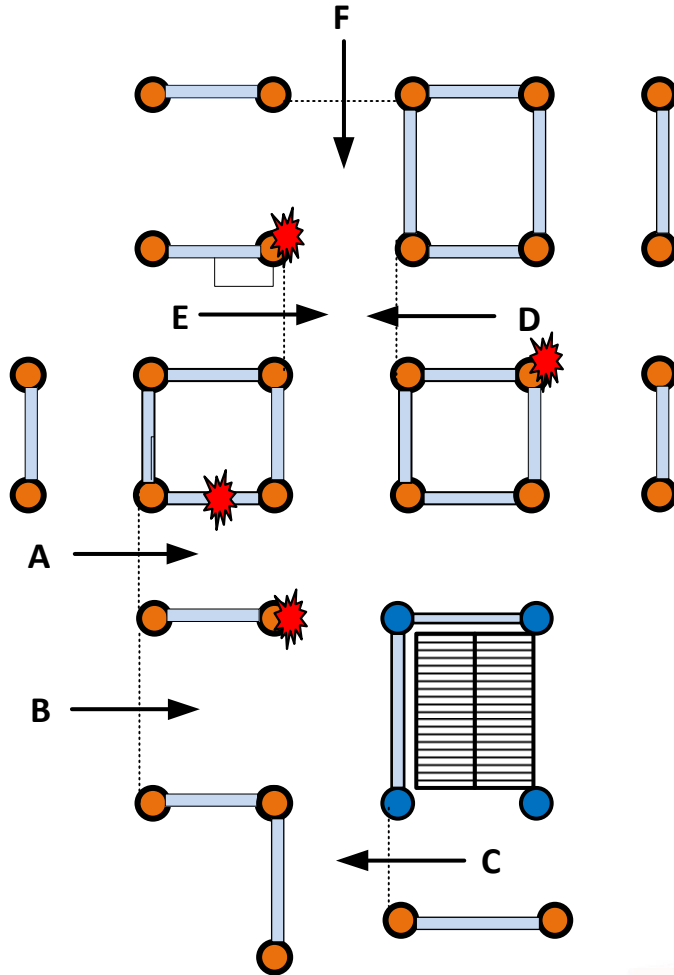

Nur Klasse S



= abwerfbare Teile = 4



Reilingen 2019

BaWü. - MS 4.- sp. Pony + Pferde + Bad. MS 1.- und 2.-sp. Pony + Pferde

H 6

Volksbank Tresor

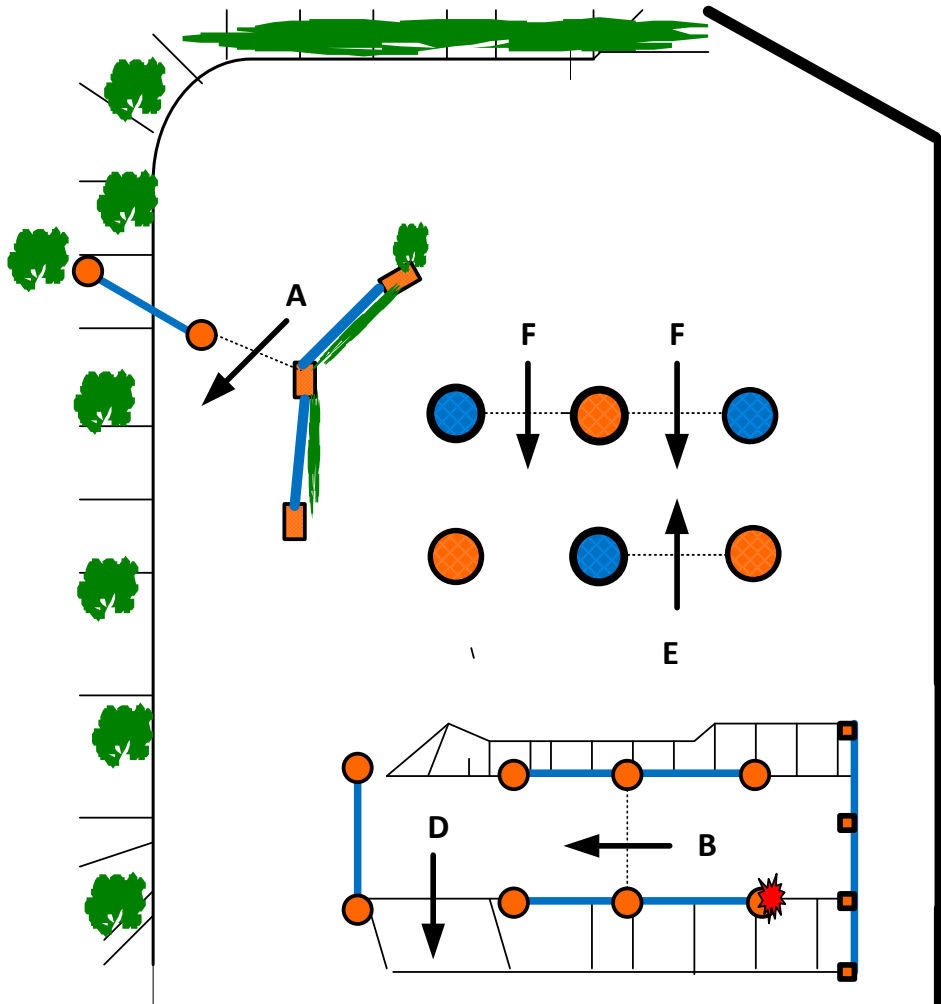
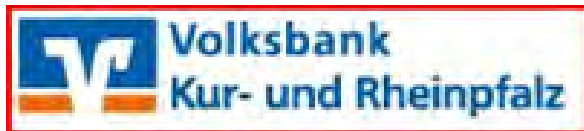

= abwerfbare Teile = 2



Klasse S: A - F
Klasse M: A - E



Reilingen 2019

BaWü. - MS 4.- sp. Pony + Pferde + Bad. MS 1.- und 2.-sp. Pony + Pferde