

Marathon Course

CAI2* Bjerke Travbane July 2018

Section A 6.600 m

Section B 6.100 m

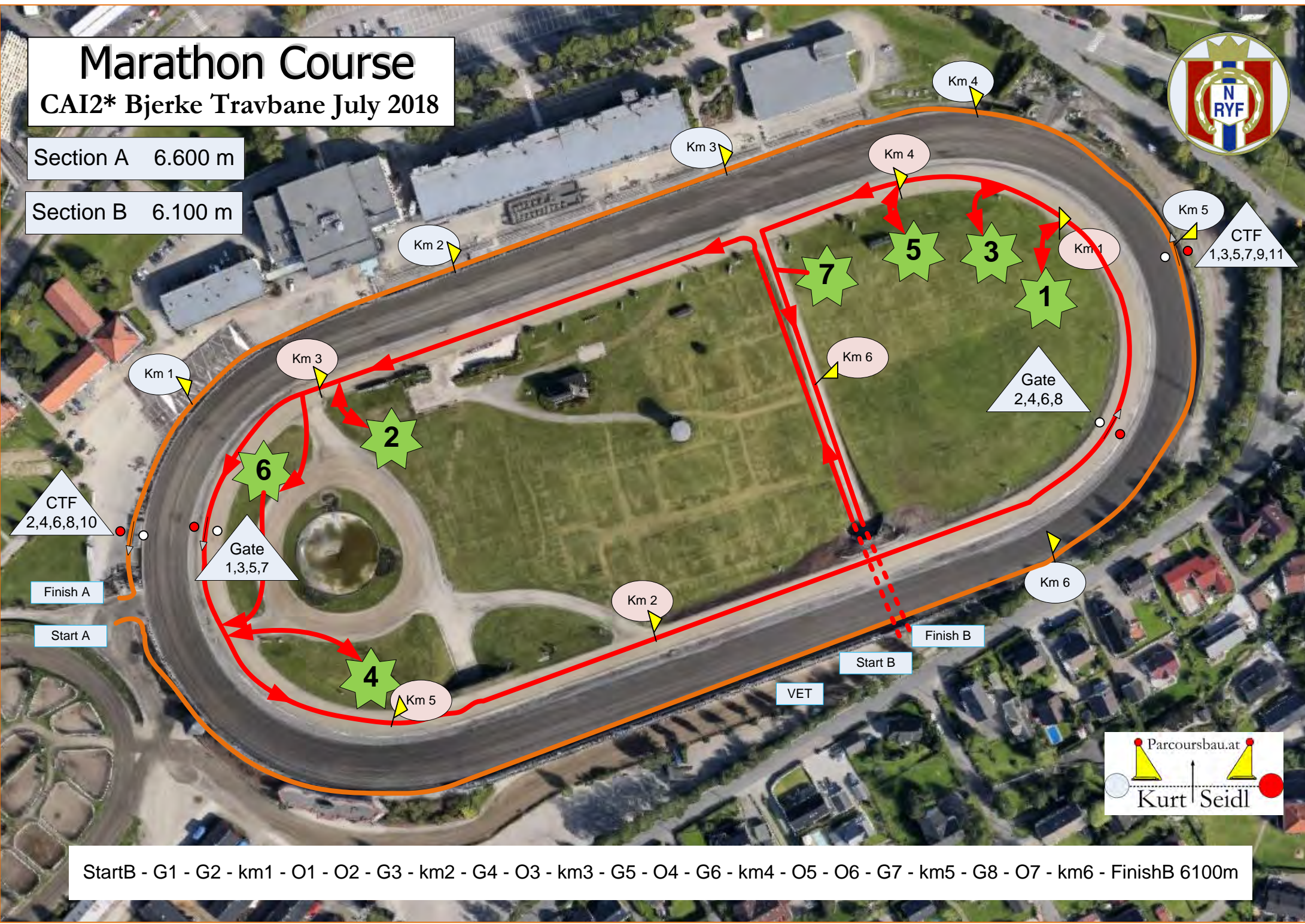

StartB - G1 - G2 - km1 - O1 - O2 - G3 - km2 - G4 - O3 - km3 - G5 - O4 - G6 - km4 - O5 - O6 - G7 - km5 - G8 - O7 - km6 - FinishB 6100m



Class S = A,B,C,D,E,F
Class J&YD = A,B,C,D,E,F
Class CH = A,B,C,D

Obstacle 1

Bales

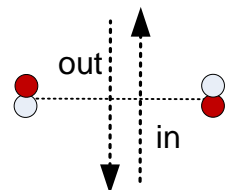
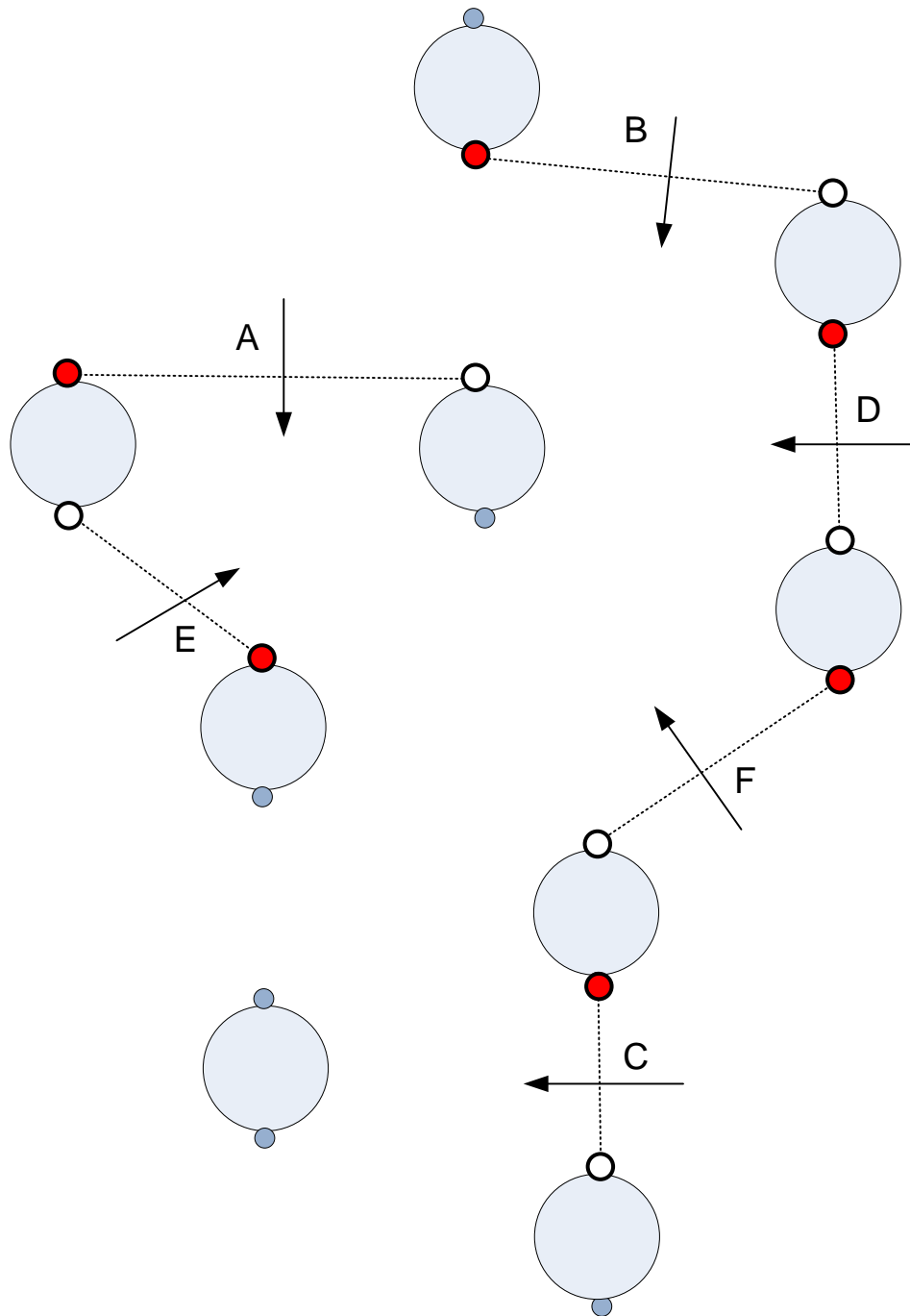





Class S = A,B,C,D,E,F
Class J&YD = A,B,C,D,E,F
Class CH = A,B,C,D

Obstacle 2

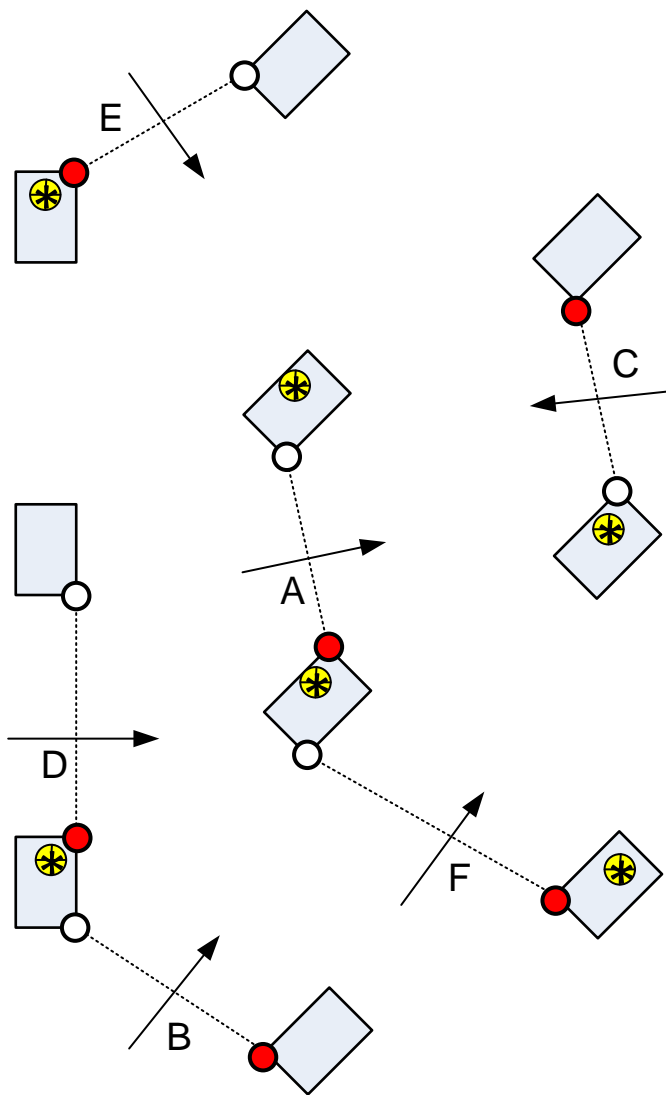
Houses



 6 Knock down

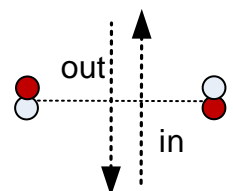
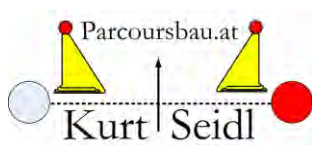



Class S = A,B,C,D,E,F
Class J&YD = A,B,C,D,E,F
Class CH = A,B,C,D

Obstacle 3

Triangles

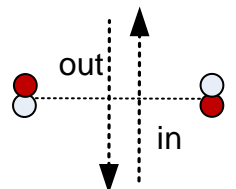
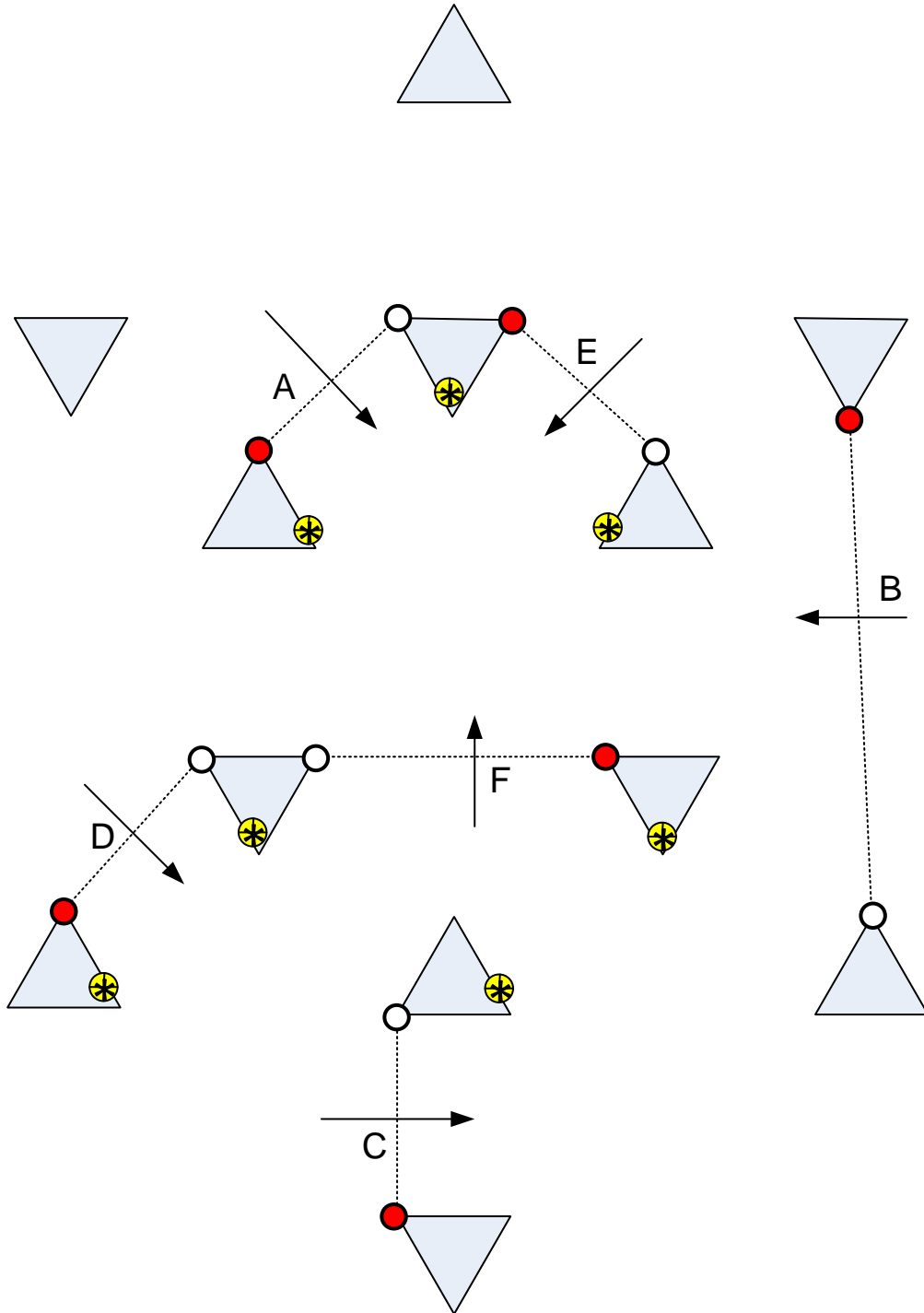



Class S = A,B,C,D,E,F
Class J&YD = A,B,C,D,E,F
Class CH = A,B,C,D

Obstacle 4

Tires

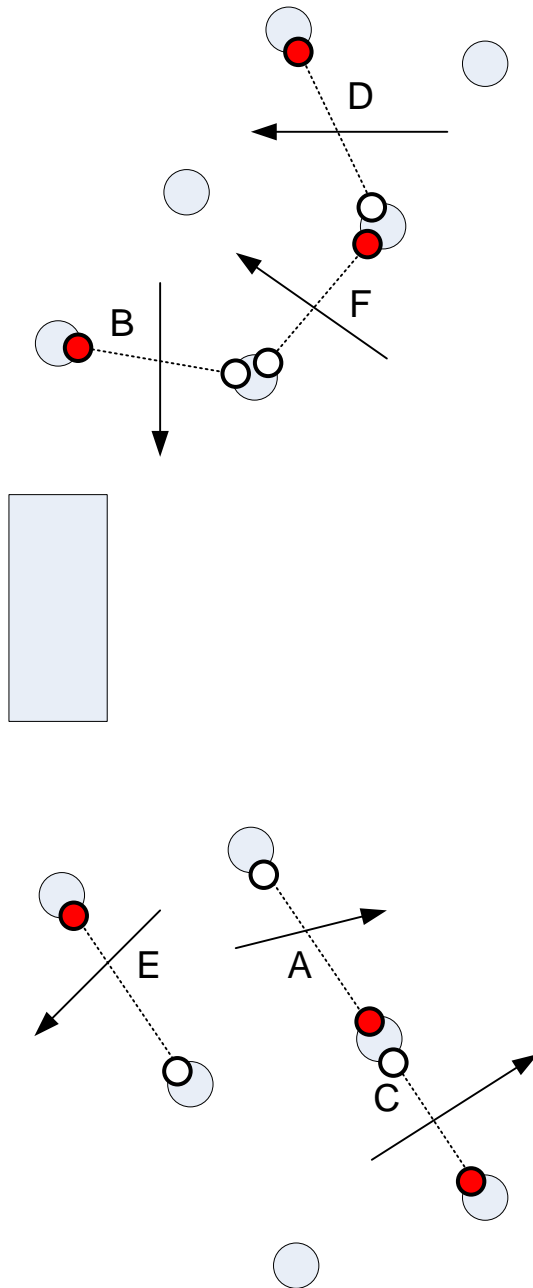
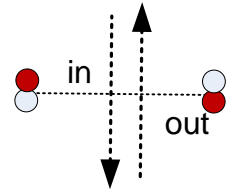



Class S = A,B,C,D,E,F
 Class J&YD = A,B,C,D,E,F

Obstacle 5

Squares

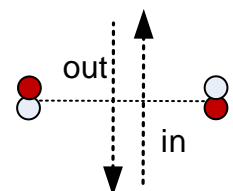
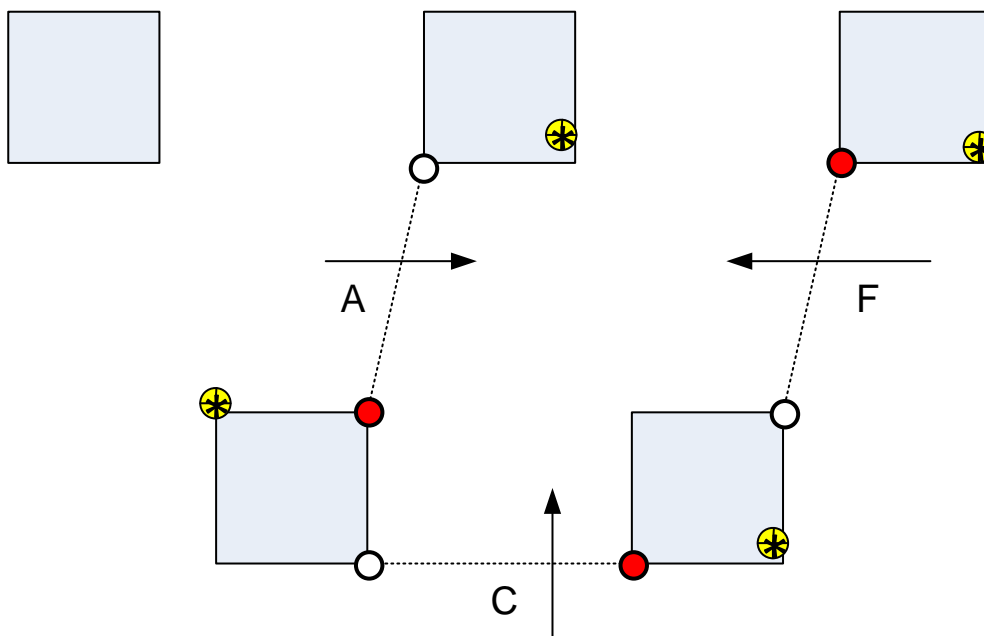
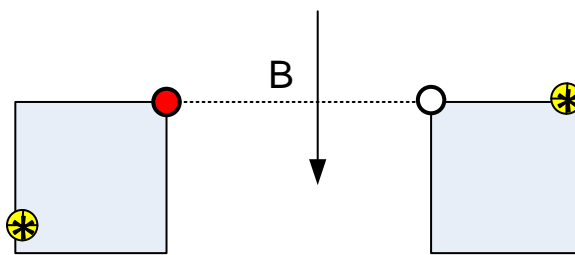
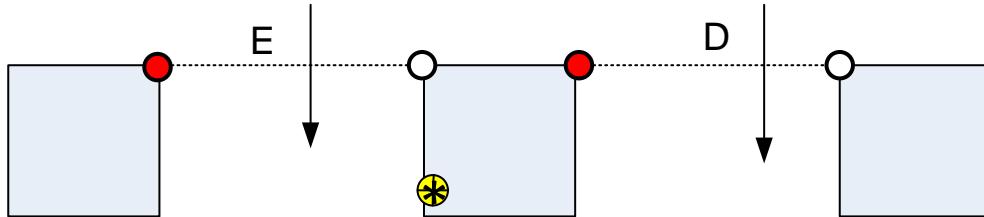



Class S = A,B,C,D,E,F

Obstacle 6

Tanks

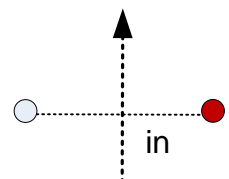
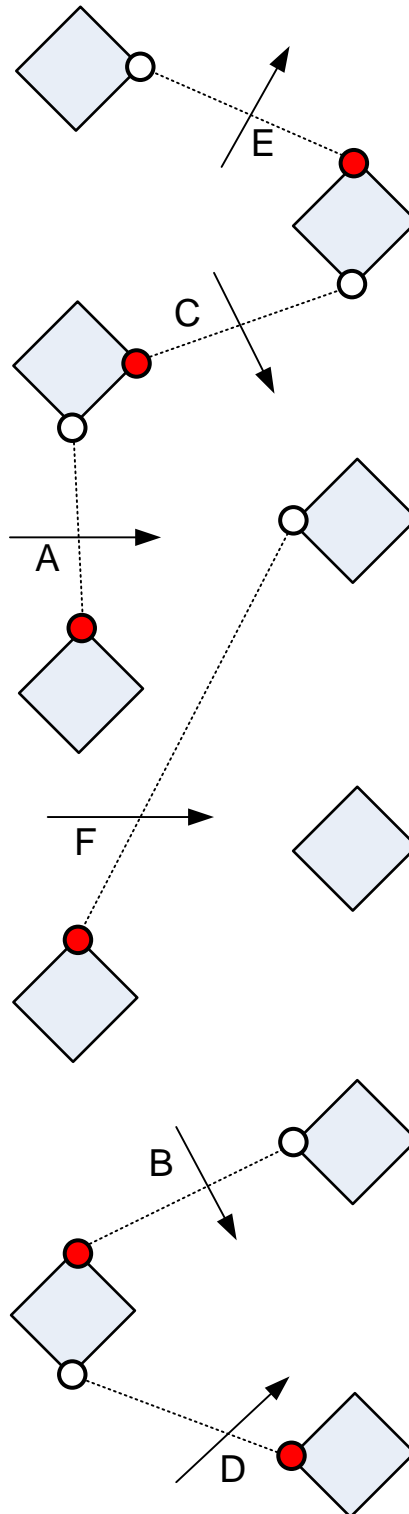
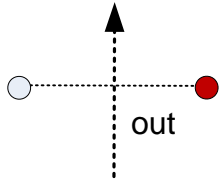



Class S = A,B,C,D,E,F
Class J&YD = A,B,C,D,E,F
Class CH = A,B,C,D

Obstacle 7

Round & Corner

