

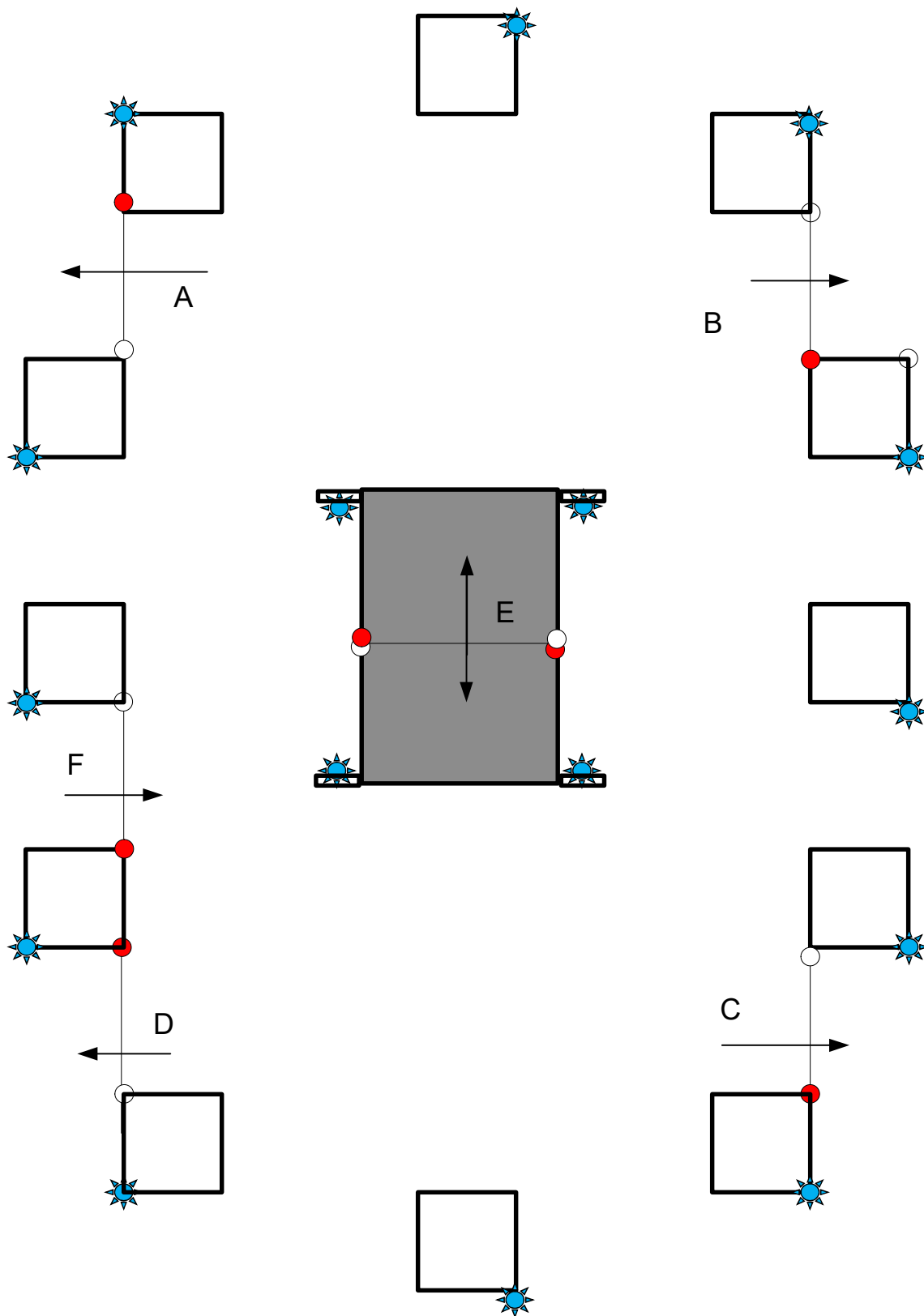

Obstacle 1: Anonymous Bridge

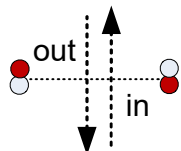

Obstacle 2: Sägewerk Stösser Bühl

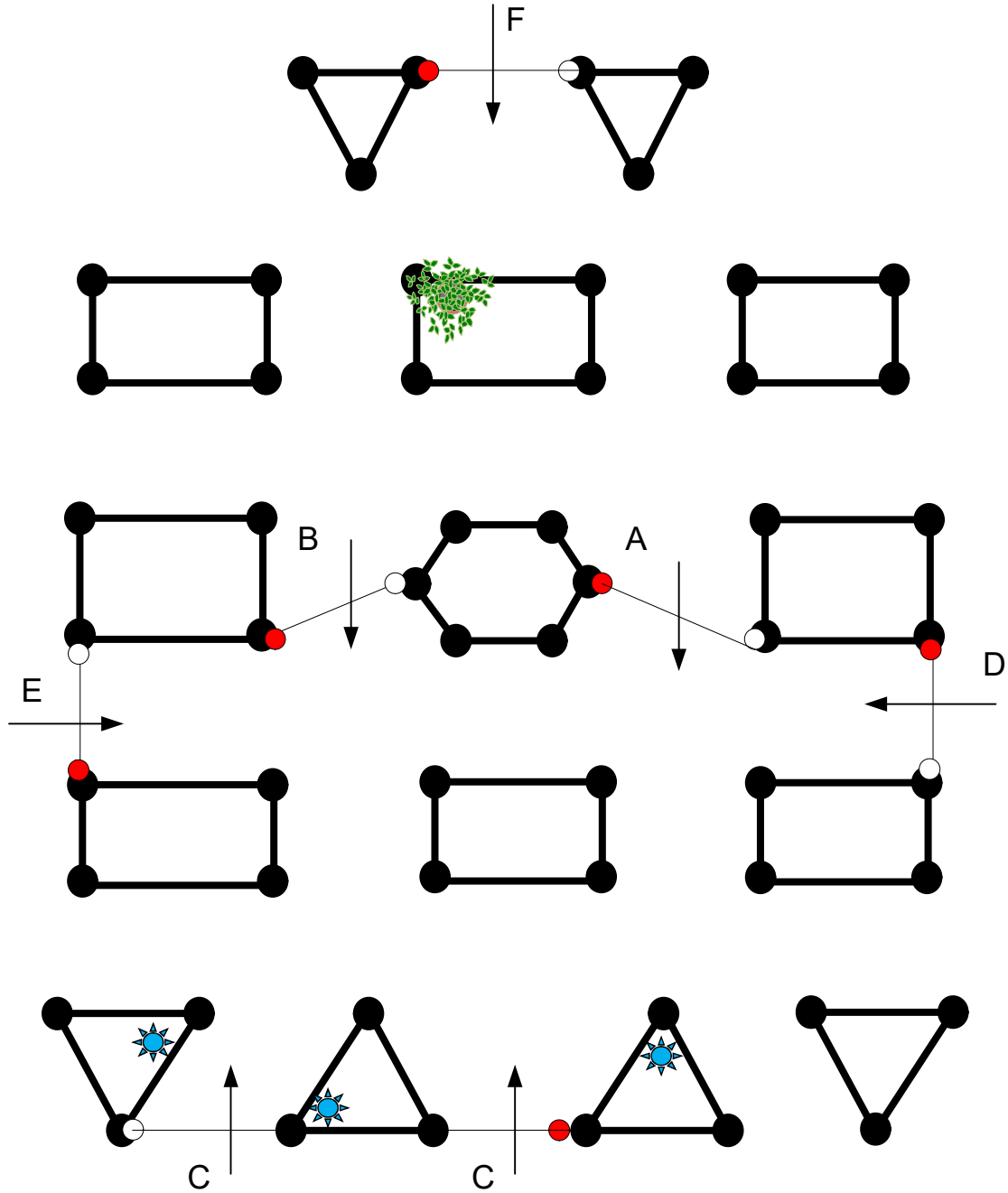

Children CAICh: A-D

 3 Knock Downs

Obstacle 3: Sicon Gescher

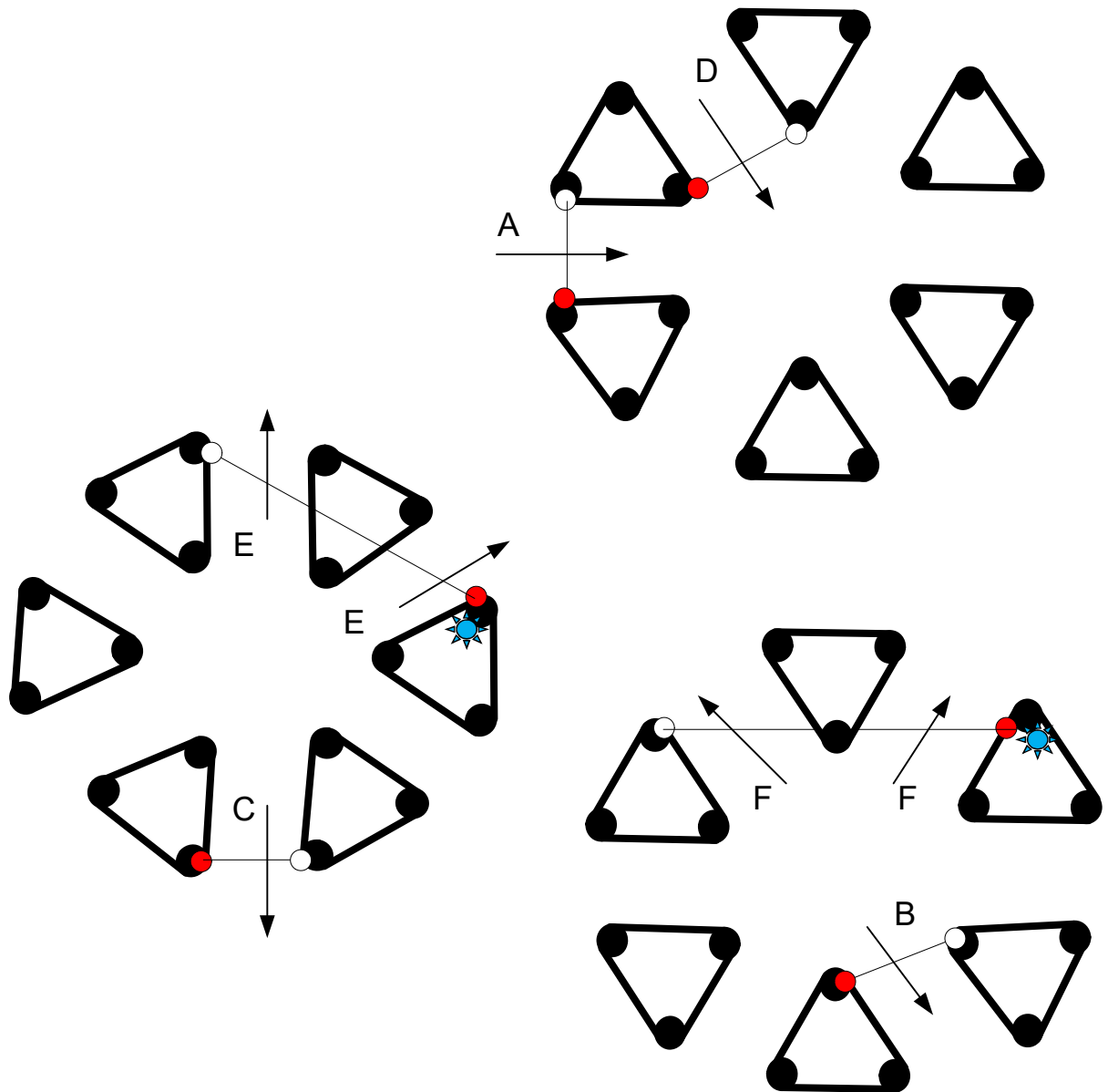

Children CAICh: A-D

 2 Knock Downs

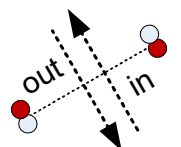

Michael Mayer | 
Course Designer michael-mayer.ch
CD-Ass.: U.Bernhard

Obstacle 4: Boehringer Ingelheim Vetmedica

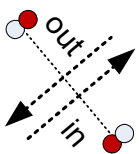
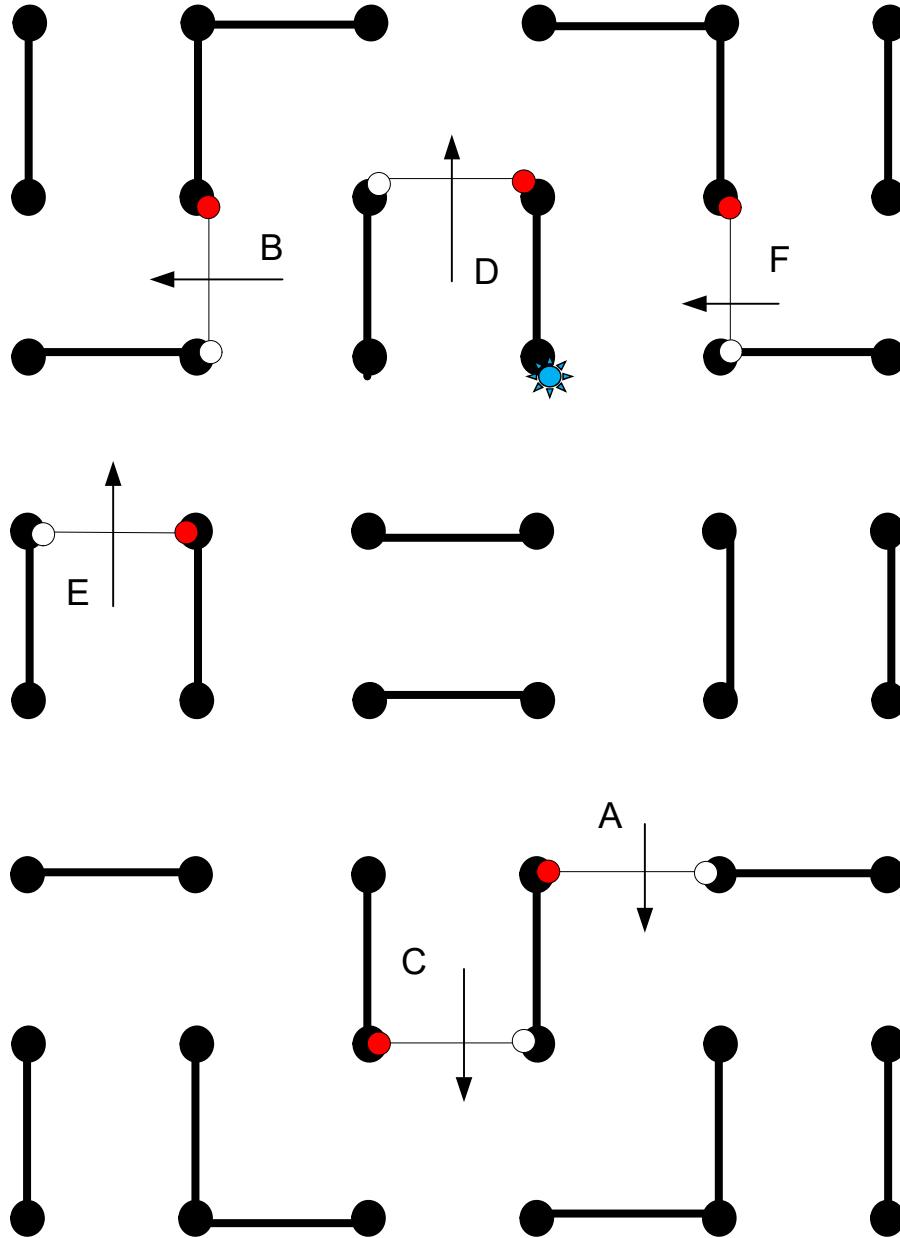

Children CAICh: A-D

☀ 1 Knock Downs

Obstacle 5: Umweltpartner Vogel AG

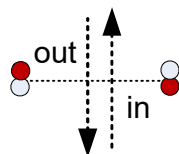
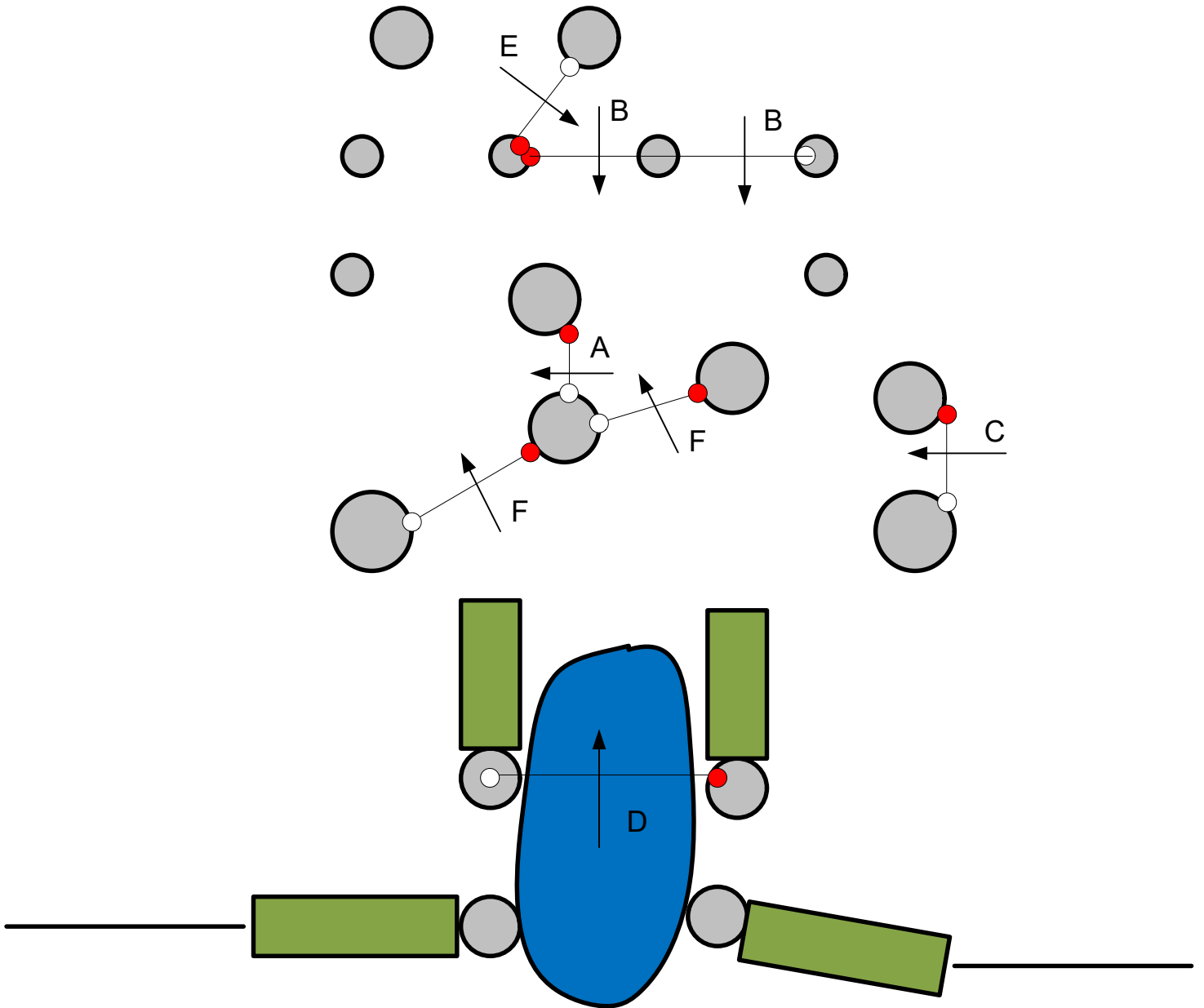

Obstacle 6: Sparkasse Bühl

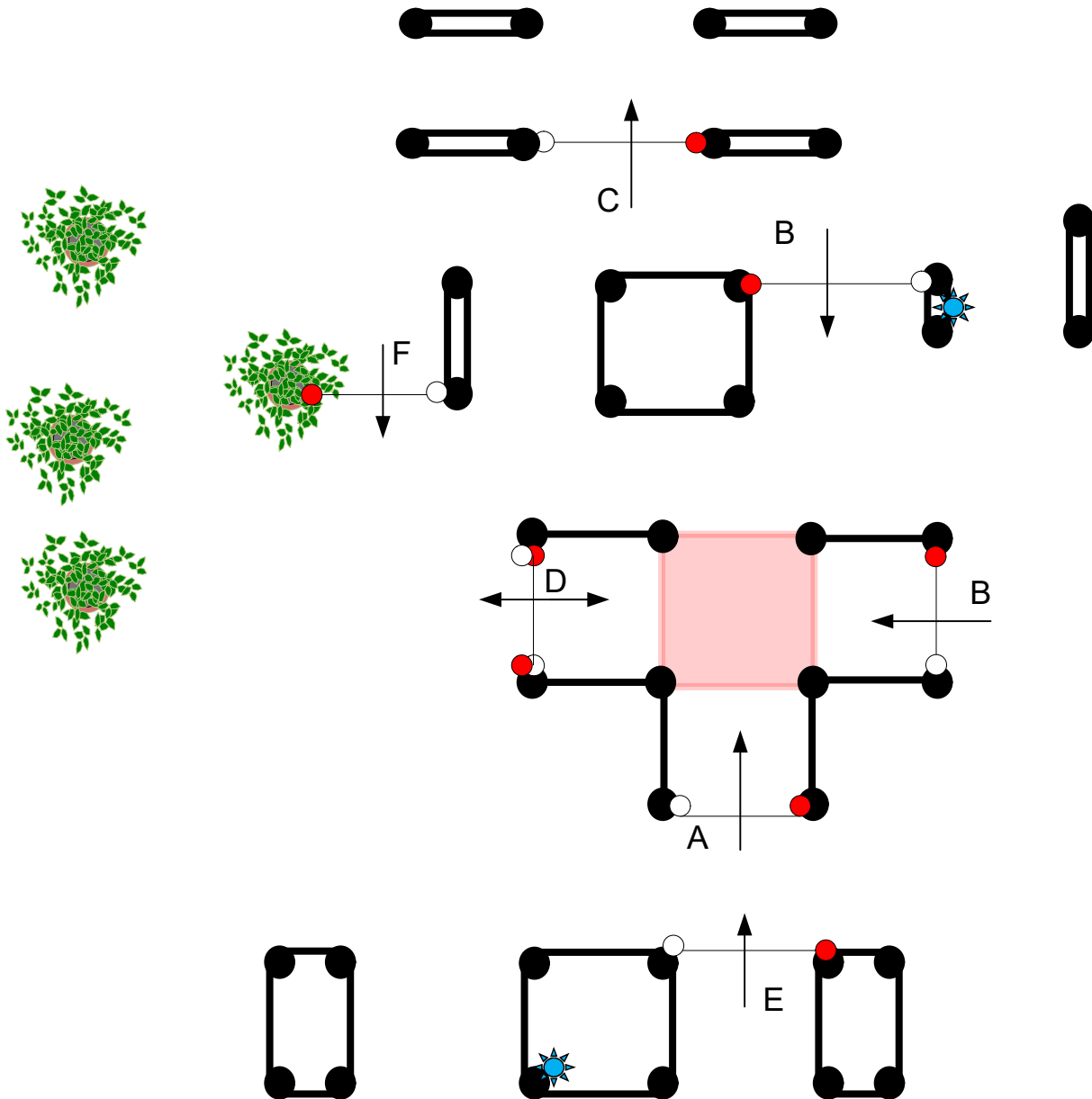

Obstacle 7: Druckerei Stolzenberger

